

**Inspur
CN6000 Series
INOS-CN System Management
Configuration Guide**



Inspur-Cisco Networking Technology Co.,Ltd. provides customers with comprehensive technical support and services.

For any assistance, please contact our local office or company headquarters.

Website: <http://www.inspur.com/>

Technical Support Tel: 400-691-1766

Technical Support Email: inspur_network@inspur.com

Technical Document Support Email: inspur_network@inspur.com

Address: 1036 Langchao Road, Lixia District, Jinan City, Shandong Province

Postal code: 250101

Notice

Copyright © 2020

Inspur Group.

All rights reserved.

No part of this publication may be excerpted, reproduced, translated or utilized in any form or by any means, electronic or mechanical, including photocopying and microfilm, without permission in Writing from **Inspur-Cisco Networking Technology Co.,Ltd.**

inspur 浪潮

is the trademark of **Inspur-Cisco Networking Technology Co.,Ltd.**

All other trademarks and trade names mentioned in this document are the property of their respective holders.

The information in this document is subject to change without notice. Every effort has been made in the preparation of this document to ensure accuracy of the contents, but all statements, information, and recommendations in this document do not constitute the warranty of any kind, express or implied

Preface

Objectives

This guide describes main functions of the CN6000 Series. To have a quick grasp of the CN6000 Series, please read this manual carefully.

Versions





The following table lists the product versions related to this document.

Product name	Version
CN6000 Series	

Conventions

Symbol conventions

The symbols that may be found in this document are defined as follows.

Symbol	Description
 Warning	Indicates a hazard with a medium or low level of risk which, if not avoided, could result in minor or moderate injury.
 Caution	Indicates a potentially hazardous situation that, if not avoided, could cause equipment damage, data loss, and performance degradation, or unexpected results.
 Note	Provides additional information to emphasize or supplement important points of the main text.
 Tip	Indicates a tip that may help you solve a problem or save time.

General conventions

Convention	Description
Boldface	Names of files, directories, folders, and users are in boldface . For example, log in as user root .
Italic	Book titles are in <i>italics</i> .
Lucida Console	Terminal display is in <code>Lucida Console</code> .

Command conventions

Convention	Description
Boldface	The keywords of a command line are in boldface .
Italic	Command arguments are in <i>italics</i> .
[]	Items (keywords or arguments) in square brackets [] are optional.
{ x y ... }	Alternative items are grouped in braces and separated by vertical bars. One is selected.
[x y ...]	Optional alternative items are grouped in square brackets and separated by vertical bars. One or none is selected.
{ x y ... } *	Alternative items are grouped in braces and separated by vertical bars. A minimum of one or a maximum of all can be selected.
[x y ...] *	The parameter before the & sign can be repeated 1 to n times.

GUI conventions

Convention	Description
Boldface	Buttons, menus, parameters, tabs, windows, and dialog titles are in boldface . For example, click OK .
>	Multi-level menus are in boldface and separated by the ">" signs. For example, choose File > Create > Folder .

Keyboard operation

Format	Description
Key	Press the key. For example, press Enter and press Tab .

Format	Description
Key 1+Key 2	Press the keys concurrently. For example, pressing Ctrl+C means the two keys should be pressed concurrently.
Key 1, Key 2	Press the keys in turn. For example, pressing Alt, A means the two keys should be pressed in turn.

Mouse operation

Action	Description
Click	Select and release the primary mouse button without moving the pointer.
Double-click	Press the primary mouse button twice continuously and quickly without moving the pointer.
Drag	Press and hold the primary mouse button and move the pointer to a certain position.

Change history

Updates between document versions are cumulative. Therefore, the latest document version contains all updates made to previous versions.

Issue 01 (2020-02-24)

Initial commercial release

CONTENTS

Preface

Preface xvii

Audience **xvii**

Document Conventions **xvii**

CHAPTER 1

New and Changed Information 1

New and Changed Information **1**

CHAPTER 2

Overview 3

System Management Features **3**

CHAPTER 3

Configuring Switch Profiles 7

Information About Switch Profiles **8**

Switch Profile Configuration Modes **8**

Configuration Validation **9**

Software Upgrades and Downgrades with Switch Profiles **10**

Prerequisites for Switch Profiles **10**

Guidelines and Limitations for Switch Profiles **10**

Configuring Switch Profiles **11**

Adding a Switch to a Switch Profile **13**

Adding or Modifying Switch Profile Commands **14**

Importing a Switch Profile **16**

Verifying Commands in a Switch Profile **18**

Isolating a Peer Switch **19**

Deleting a Switch Profile **20**

Deleting a Switch from a Switch Profile	20
Displaying the Switch Profile Buffer	21
Synchronizing Configurations After a Switch Reboot	22
Switch Profile Configuration show Commands	22
Supported Switch Profile Commands	23
Configuration Examples for Switch Profiles	24
Creating a Switch Profile on a Local and Peer Switch Example	24
Verifying the Synchronization Status Example	26
Displaying the Running Configuration	26
Displaying the Switch Profile Synchronization Between Local and Peer Switches	26
Displaying Verify and Commit on Local and Peer Switches	27
Successful and Unsuccessful Synchronization Examples	28
Configuring the Switch Profile Buffer, Moving the Buffer, and Deleting the Buffer	28

CHAPTER 4

Using Fabric Services	31
Information About FS	31
FS Distribution	32
FS Distribution Modes	32
Uncoordinated Distribution	32
Coordinated Distribution	33
Unrestricted Uncoordinated Distributions	33
Verifying the FS Distribution Status	33
FS Support for Applications	33
FS Application Requirements	33
Enabling FS for an Application	34
Verifying Application Registration Status	34
Locking the Network	35
Verifying FS Lock Status	35
Committing Changes	35
Discarding Changes	35
Saving the Configuration	36
Clearing a Locked Session	36
FS Regions	36
About FS Regions	36
Example Scenario	36

Managing FS Regions	37
Creating FS Regions	37
Assigning Applications to FS Regions	37
Moving an Application to a Different FS Region	38
Removing an Application from a Region	38
Deleting FS Regions	38
Configuring FS over IP	39
Enabling FS over IPv4	39
Verifying the FS Over IP Configuration	39
Configuring IP Multicast Addresses for FS over IP	39
Configuring IPv4 Multicast Address for FS	40
Verifying the IP Multicast Address Configuration for FS over IP	40
Default Settings for FS	40

CHAPTER 5**Configuring NTP 43**

Information About NTP	43
NTP as Time Server	44
Distributing NTP Using FS	44
Clock Manager	44
High Availability	44
Virtualization Support	45
Licensing Requirements	45
Prerequisites for NTP	45
Guidelines and Limitations for NTP	45
Default Settings	46
Configuring NTP	47
Enabling or Disabling NTP on an Interface	47
Configuring the Device as an Authoritative NTP Server	47
Configuring an NTP Server and Peer	48
Configuring NTP Authentication	49
Configuring NTP Access Restrictions	51
Configuring the NTP Source IP Address	52
Configuring the NTP Source Interface	52
Configuring an NTP Broadcast Server	53
Configuring an NTP Multicast Server	54

Configuring an NTP Multicast Client	55
Configuring NTP Logging	55
Enabling FS Distribution for NTP	56
Committing NTP Configuration Changes	57
Discarding NTP Configuration Changes	57
Releasing the FS Session Lock	57
Verifying the NTP Configuration	58
Configuration Examples for NTP	59

CHAPTER 6**Configuring PTP 61**

Information About PTP	61
PTP Device Types	62
PTP Process	62
High Availability for PTP	63
Licensing Requirements for PTP	63
Guidelines and Limitations for PTP	63
Default Settings for PTP	64
Configuring PTP	64
Configuring PTP Globally	64
Configuring PTP on an Interface	66
Verifying the PTP Configuration	67

CHAPTER 7**Configuring User Accounts and RBAC 69**

Information About User Accounts and RBAC	69
User Roles	69
User Role Policies	73
User Account Configuration Restrictions	74
User Password Requirements	74
Guidelines and Limitations for User Accounts	75
Configuring User Accounts	76
Configuring RBAC	78

- Creating User Roles and Rules **78**
- Creating Feature Groups **79**
- Changing User Role Interface Policies **80**
- Changing User Role VLAN Policies **81**

- Verifying the User Accounts and RBAC Configuration **82**
- Configuring User Accounts Default Settings for the User Accounts and RBAC **82**

CHAPTER 8**Configuring Session Manager 85**

- Information About Session Manager **85**
- Guidelines and Limitations for Session Manager **85**
- Configuring Session Manager **86**
 - Creating a Session **86**
 - Configuring ACLs in a Session **86**
 - Verifying a Session **87**
 - Committing a Session **87**
 - Saving a Session **87**
 - Discarding a Session **87**
 - Configuration Example for Session Manager **88**
- Verifying the Session Manager Configuration **88**

CHAPTER 9**Configuring the Scheduler 89**

- Information About the Scheduler **89**
 - Remote User Authentication **90**
 - Scheduler Log Files **90**
- Licensing Requirements for the Scheduler **90**
- Guidelines and Limitations for the Scheduler **90**
- Default Settings for the Scheduler **91**
- Configuring the Scheduler **91**
 - Enabling the Scheduler **91**
 - Defining the Scheduler Log File Size **92**
 - Configuring Remote User Authentication **92**
 - Defining a Job **93**
 - Deleting a Job **94**
 - Defining a Timetable **94**

- Clearing the Scheduler Log File 96
- Disabling the Scheduler 96
- Verifying the Scheduler Configuration 97
- Configuration Examples for the Scheduler 97
 - Creating a Scheduler Job 97
 - Scheduling a Scheduler Job 98
 - Displaying the Job Schedule 98
 - Displaying the Results of Running Scheduler Jobs 98
- Standards for the Scheduler 99

CHAPTER 10

- Configuring Online Diagnostics 101**
 - Information About Online Diagnostics 101
 - Bootup Diagnostics 101
 - Health Monitoring Diagnostics 102
 - Expansion Module Diagnostics 103
 - Guidelines and Limitations for Online Diagnostics 104
 - Configuring Online Diagnostics 104
 - Verifying the Online Diagnostics Configuration 105
 - Default Settings for Online Diagnostics 105
 - Parity Error Diagnostics 106
 - Clearing Parity Errors 106
 - Soft Error Recovery 107
 - Verifying Memory Table Health 107

CHAPTER 11

- Configuring the Embedded Event Manager 109**
 - Information About Embedded Event Manager 109
 - Embedded Event Manager Policies 110
 - Event Statements 110
 - Action Statements 111
 - VSH Script Policies 112
 - Licensing Requirements for Embedded Event Manager 112
 - Prerequisites for Embedded Event Manager 112
 - Guidelines and Limitations for Embedded Event Manager 112
 - Default Settings for Embedded Event Manager 113
 - Configuring Embedded Event Manager 113

- Defining an Environment Variable **113**
- Defining a User Policy Using the CLI **114**
- Configuring Event Statements **115**
- Configuring Action Statements **118**
- Defining a Policy Using a VSH Script **119**
- Registering and Activating a VSH Script Policy **120**
- Overriding a System Policy **121**
- Configuring Syslog as an EEM Publisher **122**
- Verifying the Embedded Event Manager Configuration **123**
- Configuration Examples for Embedded Event Manager **124**
- Additional References **124**
- Feature History for EEM **125**

CHAPTER 12**Configuring System Message Logging 127**

- Information About System Message Logging **127**
 - Syslog Servers **128**
- Licensing Requirements for System Message Logging **128**
- Guidelines and Limitations for System Message Logging **128**
- Default Settings for System Message Logging **129**
- Configuring System Message Logging **129**
 - Configuring System Message Logging to Terminal Sessions **129**
 - Configuring System Message Logging to a File **131**
 - Configuring Module and Facility Messages Logging **133**
 - Configuring Logging Timestamps **134**
 - Configuring the ACL Logging Cache **135**
 - Applying ACL Logging to an Interface **136**
 - Configuring a Logging Source-Interface **137**
 - Configuring the ACL Log Match Level **137**
 - Configuring Syslog Servers **138**
 - Configuring syslog on a UNIX or Linux System **139**
 - Configuring syslog Server Configuration Distribution **140**
 - Displaying and Clearing Log Files **141**
- Verifying the System Message Logging Configuration **142**

CHAPTER 13**Configuring Smart Call Home 145**

Information About Smart Call Home	145
Smart Call Home Overview	146
Smart Call Home Destination Profiles	146
Smart Call Home Alert Groups	147
Smart Call Home Message Levels	148
Call Home Message Formats	149
Guidelines and Limitations for Smart Call Home	154
Prerequisites for Smart Call Home	155
Default Call Home Settings	155
Configuring Smart Call Home	155
Registering for Smart Call Home	155
Configuring Contact Information	156
Creating a Destination Profile	157
Modifying a Destination Profile	158
Associating an Alert Group with a Destination Profile	160
Adding Show Commands to an Alert Group	160
Configuring E-Mail Server Details	161
Configuring Periodic Inventory Notifications	162
Disabling Duplicate Message Throttling	163
Enabling or Disabling Smart Call Home	164
Testing the Smart Call Home Configuration	164
Verifying the Smart Call Home Configuration	165
Sample Syslog Alert Notification in Full-Text Format	166
Sample Syslog Alert Notification in XML Format	166

CHAPTER 14**Configuring Rollback 171**

Information About Rollbacks	171
Guidelines and Limitations for Rollbacks	171
Creating a Checkpoint	172
Implementing a Rollback	173
Verifying the Rollback Configuration	173

CHAPTER 15**Configuring DNS 175**

Information About DNS Client	175
Name Servers	175

- DNS Operation **176**
- High Availability **176**
- Prerequisites for DNS Clients **176**
- Licensing Requirements for DNS Clients **176**
- Default Settings for DNS Clients **176**
- Configuring the DNS Source Interface **177**
- Configuring DNS Clients **177**

CHAPTER 16**Configuring SNMP 181**

- Information About SNMP **181**
 - SNMP Functional Overview **181**
 - SNMP Notifications **182**
 - SNMPv3 **182**
 - Security Models and Levels for SNMPv1, v2, and v3 **182**
 - User-Based Security Model **184**
 - CLI and SNMP User Synchronization **184**
 - Group-Based SNMP Access **185**
- Licensing Requirements for SNMP **185**
- Guidelines and Limitations for SNMP **185**
- Default SNMP Settings **186**
- Configuring SNMP **186**
 - Configuring the SNMP Source Interface **186**
 - Configuring SNMP Users **187**
 - Enforcing SNMP Message Encryption **188**
 - Assigning SNMPv3 Users to Multiple Roles **188**
 - Creating SNMP Communities **188**
 - Filtering SNMP Requests **189**
 - Configuring SNMP Notification Receivers **189**
 - Configuring SNMP Notification Receivers with VRFs **190**
 - Filtering SNMP Notifications Based on a VRF **191**
 - Configuring SNMP for Inband Access **192**
 - Enabling SNMP Notifications **193**
 - Configuring Link Notifications **195**
 - Disabling Link Notifications on an Interface **196**
 - Enabling One-Time Authentication for SNMP over TCP **196**

- Assigning SNMP Switch Contact and Location Information **196**
- Configuring the Context to Network Entity Mapping **197**
- Configuring the SNMP Local Engine ID **197**
- Disabling SNMP **198**
- Verifying the SNMP Configuration **199**

CHAPTER 17**Configuring RMON 201**

- Information About RMON **201**
 - RMON Alarms **201**
 - RMON Events **202**
- Configuration Guidelines and Limitations for RMON **202**
- Verifying the RMON Configuration **203**
- Default RMON Settings **203**
- Configuring RMON Alarms **203**
- Configuring RMON Events **204**

CHAPTER 18**Configuring SPAN 207**

- Information About SPAN **207**
- SPAN Sources **208**
- Characteristics of Source Ports **208**
- SPAN Destinations **208**
- Characteristics of Destination Ports **209**
- Guidelines and Limitations for SPAN **209**
- Creating or Deleting a SPAN Session **210**
- Configuring an Ethernet Destination Port **210**
- Configuring Source Ports **211**
- Configuring Source Port Channels or VLANs **212**
- Configuring the Description of a SPAN Session **213**
- Activating a SPAN Session **213**
- Suspending a SPAN Session **214**
- Displaying SPAN Information **214**
- Configuration Examples for SPAN **215**
 - Configuration Example for a SPAN Session **215**
 - Configuration Example for a Unidirectional SPAN Session **215**
 - Configuration Example for a SPAN ACL **216**

Configuration Examples for UDF-Based SPAN 216

CHAPTER 19

Configuring Local SPAN and ERSPAN 219

Information About ERSPAN 219

ERSPAN Sources 219

ERSPAN Destinations 220

ERSPAN Sessions 220

Multiple ERSPAN Sessions 221

High Availability 221

Licensing Requirements for ERSPAN 221

Prerequisites for ERSPAN 222

Guidelines and Limitations for ERSPAN 222

Default Settings for ERSPAN 225

Configuring ERSPAN 225

Configuring an ERSPAN Source Session 225

Configuring SPAN Forward Drop Traffic for ERSPAN Source Session 228

Configuring an ERSPAN ACL 229

Configuring User Defined Field (UDF) Based ACL Support 231

Configuring IPv6 User Defined Field (UDF) on ERSPAN 233

Configuring an ERSPAN Destination Session 235

Shutting Down or Activating an ERSPAN Session 237

Verifying the ERSPAN Configuration 239

Configuration Examples for ERSPAN 239

Configuration Example for an ERSPAN Source Session 239

Configuration Example for an ERSPAN Destination Session 239

Configuration Example for an ERSPAN ACL 240

Configuration Examples for UDF-Based ERSPAN 240

Additional References 241

Related Documents 241

CHAPTER 20

Configuring Graceful Insertion and Removal 243

About Graceful Insertion and Removal 243

Profiles 244

Snapshots 245

GIR Workflow **245**
Configuring the Maintenance-Mode Profile **246**
Configuring the Normal-Mode Profile **247**
Creating a Snapshot **248**
Adding Show Commands to Snapshots **250**
Triggering Graceful Removal **251**
Triggering Graceful Insertion **253**
Maintenance Mode Enhancements **254**
Verifying the GIR Configuration **255**

CHAPTER 21**Using the PCAP SNMP Parser 257**

Using the PCAP SNMP Parser **257**

CHAPTER 22**Performing Software Maintenance Upgrades (SMUs) 259**

About SMUs **259**

Package Management **260**

Prerequisites for SMUs **260**

Guidelines and Limitations for SMUs **260**

Performing a Software Maintenance Upgrade for Inspur INOS-CN **261**

Preparing for Package Installation **261**

Copying the Package File to a Local Storage Device or Network Server **262**

Adding and Activating Packages **263**

Committing the Active Package Set **264**

Deactivating and Removing Packages **265**

Downgrading Feature RPMs **266**

Displaying Installation Log Information **267**

CHAPTER 23**Configuring Tap Aggregation and MPLS Stripping 269**

Information About Tap Aggregation **269**

Network Taps **269**

Tap Aggregation **270**

Guidelines and Limitations for Tap Aggregation **271**

Information About MPLS Stripping **271**

MPLS Overview **271**

MPLS Header Stripping **271**

- Guidelines and Limitations for MPLS Stripping **272**
- Configuring Tap Aggregation **272**
 - Enabling Tap Aggregation **272**
 - Configuring a Tap Aggregation Policy **273**
 - Attaching a Tap Aggregation Policy to an Interface **274**
- Verifying the Tap Aggregation Configuration **275**
- Configuring MPLS Stripping **276**
 - Enabling MPLS Stripping **276**
 - Adding and Deleting MPLS Labels **276**
 - Clearing Label Entries **277**
 - Clearing MPLS Stripping Counters **277**
 - Configuring MPLS Label Aging **278**
 - Configuring Destination MAC Addresses **278**
- Verifying the MPLS Label Configuration **279**

CHAPTER 24

- Configuring sFlow 281**
 - Information About sFlow **281**
 - sFlow Agent **281**
 - Licensing Requirements **282**
 - Prerequisites **282**
 - Guidelines and Limitations for sFlow **282**
 - Default Settings for sFlow **282**
 - Configuring sFlow **283**
 - Enabling the sFlow Feature **283**
 - Configuring the Sampling Rate **283**
 - Configuring the Maximum Sampled Size **284**
 - Configuring the Counter Poll Interval **284**
 - Configuring the Maximum Datagram Size **285**
 - Configuring the sFlow Analyzer Address **286**
 - Configuring the sFlow Analyzer Port **287**
 - Configuring the sFlow Agent Address **287**
 - Configuring the sFlow Sampling Data Source **288**
 - Verifying the sFlow Configuration **289**
 - Configuration Examples for sFlow **289**
 - Additional References for sFlow **290**

Feature History for sFlow 290

Preface

This preface includes the following sections:

- [Audience, page xvii](#)
- [Document Conventions, page xvii](#)

Audience

This publication is for network administrators who install, configure, and maintain Inspur CN6048TP, CN6132Q-V, CN61108PC-V, and CN61108TC-V switches.

Document Conventions

Command descriptions use the following conventions:

Convention	Description
bold	Bold text indicates the commands and keywords that you enter literally as shown.
<i>Italic</i>	Italic text indicates arguments for which the user supplies the values.
[x]	Square brackets enclose an optional element (keyword or argument).
[x y]	Square brackets enclosing keywords or arguments separated by a vertical bar indicate an optional choice.
{x y}	Braces enclosing keywords or arguments separated by a vertical bar indicate a required choice.

Convention	Description
[x {y z}]	Nested set of square brackets or braces indicate optional or required choices within optional or required elements. Braces and a vertical bar within square brackets indicate a required choice within an optional element.
<i>variable</i>	Indicates a variable for which you supply values, in context where italics cannot be used.
string	A nonquoted set of characters. Do not use quotation marks around the string or the string will include the quotation marks.

Examples use the following conventions:

Convention	Description
<code>screen font</code>	Terminal sessions and information the switch displays are in screen font.
boldface screen font	Information you must enter is in boldface screen font.
<i>italic screen font</i>	Arguments for which you supply values are in italic screen font.
<>	Nonprinting characters, such as passwords, are in angle brackets.
[]	Default responses to system prompts are in square brackets.
!, #	An exclamation point (!) or a pound sign (#) at the beginning of a line of code indicates a comment line.

CHAPTER 1

New and Changed Information

This chapter contains the following sections:

- [New and Changed Information, page 1](#)

New and Changed Information

The following table provides an overview of the significant changes to this guide for the current release.

Feature	Description	Added or Changed in Release	Where Documented
Inspur INOS-CN	Initial release	7.0(3)I7(1)	

CHAPTER 2

Overview

This chapter contains the following sections:

- [System Management Features, page 3](#)

System Management Features

The system management features documented in this guide are described below:

Feature	Description
Switch Profiles	<p>Configuration synchronization allows administrators to make configuration changes on one switch and have the system automatically synchronize the configuration to a peer switch. This feature eliminates misconfigurations and reduces the administrative overhead.</p> <p>The configuration synchronization mode (config-sync) allows users to create switch profiles to synchronize local and peer switch.</p>
Precision Time Protocol	<p>The Precision Time Protocol (PTP) is a time synchronization protocol for nodes distributed across a network. Its hardware timestamp feature provides greater accuracy than other time synchronization protocols such as Network Time Protocol (NTP).</p>

Feature	Description
User Accounts and RBAC	User accounts and role-based access control (RBAC) allow you to define the rules for an assigned role. Roles restrict the authorization that the user has to access management operations. Each user role can contain multiple rules and each user can have multiple roles.
Session Manager	Session Manager allows you to create a configuration and apply it in batch mode after the configuration is reviewed and verified for accuracy and completeness.
Online Diagnostics	<p>Generic Online Diagnostics (GOLD) define a common framework for diagnostic operations across Inspur CN6000 platforms. The online diagnostic framework specifies the platform-independent fault-detection architecture for centralized and distributed systems, including the common diagnostics CLI and the platform-independent fault-detection procedures for boot-up and run-time diagnostics.</p> <p>The platform-specific diagnostics provide hardware-specific fault-detection tests and allow you to take appropriate corrective action in response to diagnostic test results.</p>
System Message Logging	<p>You can use system message logging to control the destination and to filter the severity level of messages that system processes generate. You can configure logging to a terminal session, a log file, and syslog servers on remote systems.</p> <p>System message logging is based on RFC 3164. For more information about the system message format and the messages that the device generates, see the <i>Inspur INOS-CN System Messages Reference</i>.</p>
Smart Call Home	Call Home provides an e-mail-based notification of critical system policies. Inspur INOS-CN provides a range of message formats for optimal compatibility with pager services, standard e-mail, or XML-based automated parsing applications. You can use this feature to page a network support engineer, e-mail a Network Operations Center, or use Smart Call Home services to automatically generate a case with the Technical Assistance Center.

Feature	Description
Configuration Rollback	The configuration rollback feature allows users to take a snapshot, or user checkpoint, of the Inspur INOS-CN configuration and then reapply that configuration to a switch at any point without having to reload the switch. A rollback allows any authorized administrator to apply this checkpoint configuration without requiring expert knowledge of the features configured in the checkpoint.
SNMP	The Simple Network Management Protocol (SNMP) is an application-layer protocol that provides a message format for communication between SNMP managers and agents. SNMP provides a standardized framework and a common language used for the monitoring and management of devices in a network.
RMON	RMON is an Internet Engineering Task Force (IETF) standard monitoring specification that allows various network agents and console systems to exchange network monitoring data. Inspur INOS-CN supports RMON alarms, events, and logs to monitor Inspur CN6000 devices.
SPAN	The Switched Port Analyzer (SPAN) feature (sometimes called port mirroring or port monitoring) selects network traffic for analysis by a network analyzer. The network analyzer can be a SwitchProbe or other Remote Monitoring (RMON) probes.

Feature	Description
ERSPAN	<p>Encapsulated remote switched port analyzer (ERSPAN) is used to transport mirrored traffic in an IP network. ERSPAN supports source ports, source VLANs, and destinations on different switches, which provide remote monitoring of multiple switches across your network. ERSPAN uses a generic routing encapsulation (GRE) tunnel to carry traffic between switches.</p> <p>ERSPAN consists of an ERSPAN source session, routable ERSPAN GRE-encapsulated traffic, and an ERSPAN destination session. You separately configure ERSPAN source sessions and destination sessions on different switches.</p> <p>To configure an ERSPAN source session on one switch, you associate a set of source ports or VLANs with a destination IP address, ERSPAN ID number, and virtual routing and forwarding (VRF) name. To configure an ERSPAN destination session on another switch, you associate the destinations with the source IP address, the ERSPAN ID number, and a VRF name.</p> <p>The ERSPAN source session copies traffic from the source ports or source VLANs and forwards the traffic using routable GRE-encapsulated packets to the ERSPAN destination session. The ERSPAN destination session switches the traffic to the destinations.</p>

Configuring Switch Profiles

This chapter contains the following sections:

- [Information About Switch Profiles, page 8](#)
- [Switch Profile Configuration Modes, page 8](#)
- [Configuration Validation, page 9](#)
- [Software Upgrades and Downgrades with Switch Profiles, page 10](#)
- [Prerequisites for Switch Profiles, page 10](#)
- [Guidelines and Limitations for Switch Profiles, page 10](#)
- [Configuring Switch Profiles, page 11](#)
- [Adding a Switch to a Switch Profile, page 13](#)
- [Adding or Modifying Switch Profile Commands, page 14](#)
- [Importing a Switch Profile, page 16](#)
- [Verifying Commands in a Switch Profile, page 18](#)
- [Isolating a Peer Switch, page 19](#)
- [Deleting a Switch Profile, page 20](#)
- [Deleting a Switch from a Switch Profile, page 20](#)
- [Displaying the Switch Profile Buffer, page 21](#)
- [Synchronizing Configurations After a Switch Reboot, page 22](#)
- [Switch Profile Configuration show Commands, page 22](#)
- [Supported Switch Profile Commands, page 23](#)
- [Configuration Examples for Switch Profiles, page 24](#)

Information About Switch Profiles

Several applications require consistent configuration across Inspur CN6000Series switches in the network. Mismatched configurations can cause errors or misconfigurations that can result in service disruptions.

The configuration synchronization (config-sync) feature allows you to configure one switch profile and have the configuration be automatically synchronized to the peer switch. A switch profile provides the following benefits:

- Allows configurations to be synchronized between switches.
- Merges configurations when connectivity is established between two switches.
- Provides control of exactly which configuration gets synchronized.
- Ensures configuration consistency across peers through merge and mutual-exclusion checks.
- Provides verify and commit semantics.

Switch Profile Configuration Modes

The switch profile feature includes the following configuration modes:

- Configuration Synchronization Mode
- Switch Profile Mode
- Switch Profile Import Mode

Configuration Synchronization Mode

The configuration synchronization mode (config-sync) allows you to create switch profiles using the **config sync** command on the local switch that you want to use as the master. After you create the profile, you can enter the **config sync** command on the peer switch that you want to synchronize.

Switch Profile Mode

The switch profile mode allows you to add supported configuration commands to a switch profile that is later synchronized with a peer switch. Commands that you enter in the switch profile mode are buffered until you enter the **commit** command.

Switch Profile Import Mode

After entering the **import** command, the switch profile mode (config-sync-sp) changes to the switch profile import mode (config-sync-sp-import). The switch profile import mode allows you to import existing switch configurations from the running configuration and specify which commands you want to include in the switch profile.

Because different topologies require different commands that are included in a switch profile, the **import** command mode allows you to modify the imported set of commands to suit a specific topology.

You need to enter the **commit** command to complete the import process and move the configuration into the switch profile. Because configuration changes are not supported during the import process, if you added new commands before entering the **commit** command, the switch profile remains unsaved and the switch remains in the switch profile import mode. You can remove the added commands or abort the import. Unsaved configurations are lost if the process is aborted. You can add new commands to the switch profile after the import is complete.

Configuration Validation

Two types of configuration validation checks can identify two types of switch profile failures:

- Mutual Exclusion Checks
- Merge Checks

Mutual Exclusion Checks

To reduce the possibility of overriding configuration settings that are included in a switch profile, mutual exclusion (mutex) checks the switch profile commands against the commands that exist on the local switch and the commands on the peer switch. A command that is included in a switch profile cannot be configured outside of the switch profile or on a peer switch. This requirement reduces the possibility that an existing command is unintentionally overwritten.

As a part of the commit process, the mutex-check occurs on both switches if the peer switch is reachable; otherwise, the mutex-check is performed locally. Configuration changes made from the configuration terminal occur only on the local switch.

If a mutex-check identifies errors, they are reported as mutex failures and they must be manually corrected.

The following exceptions apply to the mutual exclusion policy:

- Interface configuration—Port channel interfaces must be configured fully in either switch profile mode or global configuration mode.



Note Several port channel subcommands are not configurable in switch profile mode. These commands can be configured from global configuration mode even if the port channel is created and configured in switch profile mode.

For example, the following command can only be configured in global configuration mode:

```
switchport private-vlan association trunk primary-vlan secondary-vlan
```

- Shutdown/no shutdown
- System QoS

Merge Checks

Merge checks are done on the peer switch that is receiving a configuration. The merge checks ensure that the received configuration does not conflict with the switch profile configuration that already exists on the receiving switch. The merge check occurs during the merge or commit process. Errors are reported as merge failures and must be manually corrected.

When one or both switches are reloaded and the configurations are synchronized for the first time, the merge check verifies that the switch profile configurations are identical on both switches. Differences in the switch profiles are reported as merge errors and must be manually corrected.

Software Upgrades with Switch Profiles

When you perform an In Service Software Upgrade (ISSU) on one of the switches included in a switch profile, a configuration synchronization cannot occur because the peer is unreachable.

Prerequisites for Switch Profiles

Switch profiles have the following prerequisites:

- You must enable Fabric Series over IP (FSoIP) distribution over mgmt0 on both switches by entering the **FS ipv4 distribute** command.
- You must configure a switch profile with the same name on both peer switches by entering the **config sync** and **switch-profile** commands.
- Configure each switch as peer switch by entering the **sync-peers destination** command

Guidelines and Limitations for Switch Profiles

Consider the following guidelines and limitations when configuring switch profiles:

- You can only enable configuration synchronization using the mgmt0 interface.
- Configuration synchronization is performed using the mgmt 0 interface and cannot be performed using a management SVI.
- You must configure synchronized peers with the same switch profile name.
- Commands that are qualified for a switch profile configuration are allowed to be configured in the configuration switch profile (config-sync-sp) mode.
- One switch profile session can be in progress at a time. Attempts to start another session will fail.
- Supported command changes made from the configuration terminal mode are blocked when a switch profile session is in progress. You should not make unsupported command changes from the configuration terminal mode when a switch profile session is in progress.
- When you enter the **commit** command and a peer switch is reachable, the configuration is applied to both peer switches or neither switch. If there is a commit failure, the commands remain in the switch profile buffer. You can then make necessary corrections and try the commit again.

- Once a port channel is configured using switch profile mode, it cannot be configured using global configuration (config terminal) mode.



Note Several port channel sub-commands are not configurable in switch profile mode. These commands can be configured from global configuration mode even if the port channel is created and configured in switch profile mode.

For example, the following command can only be configured in global configuration mode:

```
switchport private-vlan association trunk primary-vlan secondary-vlan
```

- Shutdown and no shutdown can be configured in either global configuration mode or switch profile mode.
- If a port channel is created in global configuration mode, channel groups including member interfaces must also be created using global configuration mode.
- Port channels that are configured within switch profile mode may have members both inside and outside of a switch profile.
- If you want to import a member interface to a switch profile, the port channel including the member interface must also be present within the switch profile.

Guidelines for Synchronizing After Connectivity Loss

- Synchronizing configurations after mgmt0 interface connectivity loss—When mgmt0 interface connectivity is lost and configuration changes are required, apply the configuration changes on both switches using the switch profile. When connectivity to the mgmt0 interface is restored, both switches synchronize automatically.

If a configuration change is made on only one switch, a merge will occur when the mgmt0 interface comes up and the configuration is applied on the other switch.

Configuring Switch Profiles

You can create and configure a switch profile. Enter the **switch-profile name** command in the configuration synchronization mode (config-sync).

Before You Begin

You must create the switch profile with the same name on each switch and the switches must configure each other as a peer. When connectivity is established between switches with the same active switch profile, the switch profiles are synchronized.

Procedure

	Command or Action	Purpose
Step 1	configure terminal Example: switch# configure terminal switch(config)#	Enters global configuration mode.
Step 2	FS ipv4 distribute Example: switch(config)# FS ipv4 distribute switch(config)#	Enables FS distribution between the peer switches.
Step 3	config sync Example: switch# config sync switch(config-sync)#	Enters configuration synchronization mode.
Step 4	switch-profile name Example: switch(config-sync)# switch-profile abc switch(config-sync-sp)#	Configures the switch profile, names the switch profile, and enters switch profile synchronization configuration mode.
Step 5	sync-peers destination IP-address Example: switch(config-sync-sp)# sync-peers destination 10.1.1.1 switch(config-sync-sp)#	Configures the peer switch.
Step 6	show switch-profile name status Example: switch(config-sync-sp)# show switch-profile abc status switch(config-sync-sp)#	(Optional) Views the switch profile on the local switch and the peer switch information.
Step 7	exit Example: switch(config-sync-sp)# exit switch#	Exits the switch profile configuration mode and returns to EXEC mode.
Step 8	copy running-config startup-config Example: switch(config)# copy running-config startup-config	(Optional) Saves the change persistently through reboots and restarts by copying the running configuration to the startup configuration.

The following example shows how to configure a switch profile and shows the switch profile status.

```
switch# configuration terminal
switch(config)# FS ipv4 distribute
```

```

switch(config-sync)# switch-profile abc
switch(config-sync-sp)# sync-peers destination 10.1.1.1
switch(config-sync-sp)# show switch-profile abc status
Start-time: 15801 usecs after Mon Oct 02 06:21:08 2017
End-time: 6480 usecs after Mon Oct 02 06:21:13 2017

Profile-Revision: 1
Session-type: Initial-Exchange
Peer-triggered: Yes
Profile-status: Sync Success

Local information:
-----
Status: Commit Success
Error(s):

Peer information:
-----
IP-address: 10.1.1.1
Sync-status: In Sync.
Status: Commit Success
Error(s):
switch(config-sync-sp)#
exit switch#
    
```

Adding a Switch to a Switch Profile

Enter the **sync-peers destination** *destination IP* command in switch profile configuration mode to add the switch to a switch profile.

Follow these guidelines when adding switches:

- Switches are identified by their IP address.
- Destination IPs are the IP addresses of the switches that you want to synchronize.
- The committed switch profile is synchronized with the newly added peers (when they are online) if the peer switch is also configured with configuration synchronization.

If you want to import a member interface to a switch profile, the port channel including the member interface must also be present within the switch profile.

Before You Begin

After creating a switch profile on the local switch, you must add the second switch that will be included in the synchronization.

Procedure

	Command or Action	Purpose
Step 1	config sync Example: switch# config sync switch(config-sync)#	Enters configuration synchronization mode.

	Command or Action	Purpose
Step 2	switch-profile <i>name</i> Example: switch(config-sync)# switch-profile abc switch(config-sync-sp)#	Configures switch profile, names the switch profile, and enters switch profile synchronization configuration mode.
Step 3	sync-peers destination <i>destination IP</i> Example: switch(config-sync-sp)# sync-peers destination 10.1.1.1 switch(config-sync-sp)#	Adds a switch to the switch profile.
Step 4	exit Example: switch(config-sync-sp)# exit switch#	Exits switch profile configuration mode.
Step 5	show switch-profile peer Example: switch# show switch-profile peer	(Optional) Displays the switch profile peer configuration.
Step 6	copy running-config startup-config Example: switch# copy running-config startup-config	(Optional) Copies the running configuration to the startup configuration.

Adding or Modifying Switch Profile Commands

To modify a command in a switch profile, add the modified command to the switch profile and enter the **commit** command to apply the command and synchronize the switch profile to the peer switch if it is reachable.

Follow these guidelines when adding or modifying switch profile commands:

- Commands that are added or modified are buffered until you enter the **commit** command.
- Commands are executed in the same order in which they are buffered. If there is an order-dependency for certain commands, for example, a QoS policy must be defined before being applied, you must maintain that order; otherwise, the commit might fail. You can use utility commands, such as the **show switch-profile name buffer** command, the **buffer-delete** command, or the **buffer-move** command, to change the buffer and correct the order of already entered commands.

Before You Begin

After configuring a switch profile on the local and the peer switch, you must add and commit the supported commands to the switch profile. The commands are added to the switch profile buffer until you enter the **commit** command. The **commit** command does the following:

- Triggers the mutex check and the merge check to verify the synchronization.

- Creates a checkpoint with a rollback infrastructure.
- Applies the configuration on the local switch and the peer switch.
- Executes a rollback on all switches if there is a failure with an application on any of the switches in the switch profile.
- Deletes the checkpoint.

Procedure

	Command or Action	Purpose
Step 1	config sync Example: switch# config sync switch(config-sync)#	Enters configuration synchronization mode.
Step 2	switch-profile name Example: switch(config-sync)# switch-profile abc switch(config-sync-sp)#	Configures the switch profile, names the switch profile, and enters switch profile synchronization configuration mode.
Step 3	<i>Command argument</i> Example: switch(config-sync-sp)# interface Port-channel100 switch(config-sync-sp-if)# speed 1000 switch(config-sync-sp-if)# interface Ethernet1/1 switch(config-sync-sp-if)# speed 1000 switch(config-sync-sp-if)# channel-group 100	Adds a command to the switch profile.
Step 4	show switch-profile name buffer Example: switch(config-sync-sp)# show switch-profile abc buffer switch(config-sync-sp)#	(Optional) Displays the configuration commands in the switch profile buffer.
Step 5	verify Example: switch(config-sync-sp)# verify	Verifies the commands in the switch profile buffer.
Step 6	commit Example: switch(config-sync-sp)# commit	Saves the commands in the switch profile and synchronizes the configuration with the peer switch.
Step 7	show switch-profile name status Example: switch(config-sync-sp)# show switch-profile abc status switch(config-sync-sp)#	(Optional) Displays the status of the switch profile on the local switch and the status on the peer switch.

	Command or Action	Purpose
Step 8	exit Example: switch(config-sync-sp)# exit switch#	Exits the switch profile configuration mode.
Step 9	copy running-config startup-config Example: switch# copy running-config startup-config	(Optional) Copies the running configuration to the startup configuration.

The following example shows how to create a switch profile, configure a peer switch, and add commands to the switch profile.

```
switch# configuration terminal
switch(config)# FS ipv4 distribute
switch(config-sync)# switch-profile abc
switch(config-sync-sp)# sync-peers destination 10.1.1.1
switch(config-sync-sp)# interface port-channel100
switch(config-sync-sp-if)# speed 1000
switch(config-sync-sp-if)# interface Ethernet1/1
switch(config-sync-sp-if)# speed 1000
switch(config-sync-sp-if)# channel-group 100
switch(config-sync-sp)# verify
switch(config-sync-sp)# commit
switch(config-sync-sp)# exit
switch#
```

The following example shows an existing configuration with a defined switch profile. The second example shows how the **switch profile** command changed by adding the modified command to the switch profile.

```
switch# show running-config
switch-profile abc
  interface Ethernet1/1
    switchport mode trunk
    switchport trunk allowed vlan 1-10
switch# config sync
switch(config-sync)# switch-profile abc
switch(config-sync-sp)# interface Ethernet1/1
switch(config-sync-sp-if)# switchport trunk allowed vlan 5-10
switch(config-sync-sp-if)# commit
switch# show running-config
switch-profile abc
  interface Ethernet1/1
    switchport mode trunk
    switchport trunk allowed vlan 5-10
```

Importing a Switch Profile

You can import a switch profile based on the set of commands that you want to import. Using the configuration terminal mode, you can do the following:

- Add selected commands to the switch profile.
- Add supported commands that were specified for an interface.

- Add supported system-level commands.
- Add supported system-level commands excluding the physical interface commands.

When you import commands to a switch profile, the switch profile buffer must be empty.

If new commands are added during the import, the switch profile remains unsaved and the switch remains in the switch profile import mode. You can enter the **abort** command to stop the import. For additional information importing a switch profile, see the “Switch Profile Import Mode” section.

Procedure

	Command or Action	Purpose
Step 1	config sync Example: switch# config sync switch(config-sync)#	Enters configuration synchronization mode.
Step 2	switch-profile name Example: switch(config-sync)# switch-profile abc switch(config-sync-sp)#	Configures the switch profile, names the switch profile, and enters switch profile synchronization configuration mode.
Step 3	import {interface port/slot running-config [exclude interface ethernet]} Example: switch(config-sync-sp)# import ethernet 1/2 switch(config-sync-sp-import)#	Identifies the commands that you want to import and enters switch profile import mode. <ul style="list-style-type: none"> • <CR>—Adds selected commands. • interface—Adds the supported commands for a specified interface. • running-config—Adds supported system-level commands. • running-config exclude interface ethernet—Adds supported system-level commands excluding the physical interface commands.
Step 4	commit Example: switch(config-sync-sp-import)# commit	Imports the commands and saves the commands to the switch profile.
Step 5	abort Example: switch(config-sync-sp-import)# abort	(Optional) Aborts the import process.

	Command or Action	Purpose
Step 6	exit Example: switch(config-sync-sp)# exit switch#	Exits switch profile import mode.
Step 7	show switch-profile Example: switch# show switch-profile	(Optional) Displays the switch profile configuration.
Step 8	copy running-config startup-config Example: switch# copy running-config startup-config	(Optional) Copies the running configuration to the startup configuration.

The following example shows how to import supported system-level commands excluding the Ethernet interface commands into the switch profile named sp:

```
switch(config-vlan)# conf sync
switch(config-sync)# switch-profile sp
Switch-Profile started, Profile ID is 1
switch(config-sync-sp)# show switch-profile buffer
switch-profile : sp
-----
Seq-no  Command
-----

switch(config-sync-sp)# import running-config exclude interface ethernet
switch(config-sync-sp-import)#
switch(config-sync-sp-import)# show switch-profile buffer
switch-profile : sp
-----
Seq-no  Command
-----
3      vlan 100-299
4      vlan 300
4.1    state suspend
5      vlan 301-345
6      interface port-channel100
6.1    spanning-tree port type network
7      interface port-channel105
switch(config-sync-sp-import)#
```

Verifying Commands in a Switch Profile

You can verify the commands that are included in a switch profile by entering the **verify** command in switch profile mode.

Procedure

	Command or Action	Purpose
Step 1	config sync Example: switch# config sync switch(config-sync)#	Enters configuration synchronization mode.
Step 2	switch-profile name Example: switch(config-sync)# switch-profile abc switch(config-sync-sp)#	Configures the switch profile, names the switch profile, and enters switch profile synchronization configuration mode.
Step 3	verify Example: switch(config-sync-sp)# verify	Verifies the commands in the switch profile buffer.
Step 4	exit Example: switch(config-sync-sp)# exit switch#	Exits the switch profile configuration mode.
Step 5	copy running-config startup-config Example: switch# copy running-config startup-config	(Optional) Copies the running configuration to the startup configuration.

Isolating a Peer Switch

You can isolate a peer switch in order to make changes to a switch profile. This process can be used when you want to block a configuration synchronization or when you want to debug configurations. Isolating a peer switch requires that you remove the switch from the switch profile and then add the peer switch back to the switch profile.

To temporarily isolate a peer switch, follow these steps:

- 1 Remove a peer switch from a switch profile.
- 2 Make changes to the switch profile and commit the changes.
- 3 Enter debug commands.
- 4 Undo the changes that were made to the switch profile in Step 2 and commit.
- 5 Add the peer switch back to the switch profile.

Deleting a Switch Profile

You can delete a switch profile by selecting the **all-config** or the **local-config** option:

- **all-config**—Deletes the switch profile on both peer switches (when both are reachable). If you choose this option and one of the peers is unreachable, only the local switch profile is deleted. The **all-config** option completely deletes the switch profile on both peer switches.
- **local-config**—Deletes the switch profile on the local switch only.

Procedure

	Command or Action	Purpose
Step 1	config sync Example: <pre>switch# config sync switch(config-sync)#</pre>	Enters configuration synchronization mode.
Step 2	no switch-profile name {all-config local-config} Example: <pre>switch(config-sync)# no switch-profile abc local-config switch(config-sync-sp)#</pre>	Deletes the switch profile as follows: <ul style="list-style-type: none"> • all-config—Deletes the switch profile on the local and peer switch. If the peer switch is not reachable, only the local switch profile is deleted. • local-config—Deletes the switch profile and local configuration.
Step 3	exit Example: <pre>switch(config-sync-sp)# exit switch#</pre>	Exits configuration synchronization mode.
Step 4	copy running-config startup-config Example: <pre>switch# copy running-config startup-config</pre>	(Optional) Copies the running configuration to the startup configuration.

Deleting a Switch from a Switch Profile

You can delete a switch from a switch profile.

Procedure

	Command or Action	Purpose
Step 1	config sync Example: switch# config sync switch(config-sync)#	Enters configuration synchronization mode.
Step 2	switch-profile name Example: switch(config-sync)# switch-profile abc switch(config-sync-sp)#	Configures the switch profile, names the switch profile, and enters the switch profile synchronization configuration mode.
Step 3	no sync-peers destination destination IP Example: switch(config-sync-sp)# no sync-peers destination 10.1.1.1 switch(config-sync-sp)#	Removes the specified switch from the switch profile.
Step 4	exit Example: switch(config-sync-sp)# exit switch#	Exits the switch profile configuration mode.
Step 5	show switch-profile Example: switch# show switch-profile	(Optional) Displays the switch profile configuration.
Step 6	copy running-config startup-config Example: switch# copy running-config startup-config	(Optional) Copies the running configuration to the startup configuration.

Displaying the Switch Profile Buffer

Procedure

	Command or Action	Purpose
Step 1	switch# configure sync	Enters configuration synchronization mode.
Step 2	switch(config-sync) # switch-profile profile-name	Enters switch profile synchronization configuration mode for the specified switch profile.

	Command or Action	Purpose
Step 3	switch(config-sync-sp) # show switch-profile <i>profile-name</i> buffer	Enters interface switch profile synchronization configuration mode for the specified interface.

The following example shows how to display the switch profile buffer for a service profile called sp:

```
switch# configure sync
Enter configuration commands, one per line. End with CNTL/Z.
switch(config-sync)# switch-profile sp
Switch-Profile started, Profile ID is 1
switch(config-sync-sp)# show switch-profile sp buffer
-----
Seq-no  Command
-----
1      vlan 101
1.1    ip igmp snooping querier 10.101.1.1
2      mac address-table static 0000.0000.0001 vlan 101 drop
3      interface Ethernet1/2
3.1    switchport mode trunk
3.2    switchport trunk allowed vlan 101
switch(config-sync-sp)# buffer-move 3 1
switch(config-sync-sp)# show switch-profile sp buffer
-----
Seq-no  Command
-----
1      interface Ethernet1/2
1.1    switchport mode trunk
1.2    switchport trunk allowed vlan 101
2      vlan 101
2.1    ip igmp snooping querier 10.101.1.1
3      mac address-table static 0000.0000.0001 vlan 101 drop
switch(config-sync-sp)#
```

Synchronizing Configurations After a Switch Reboot

If a Inspur CN6000Series switch reboots while a new configuration is being committed on a peer switch using a switch profile, complete the following steps to synchronize the peer switches after reload:

Procedure

-
- Step 1** Reapply configurations that were changed on the peer switch during the reboot.
 - Step 2** Enter the **commit** command.
 - Step 3** Verify that the configuration is applied correctly and both peers are back synchronized.
-

Switch Profile Configuration show Commands

The following **show** commands display information about the switch profile.

Command	Purpose
show switch-profile <i>name</i>	Displays the commands in a switch profile.
show switch-profile <i>name</i> buffer	Displays the uncommitted commands in a switch profile, the commands that were moved, and the commands that were deleted.
show switch-profile <i>name</i> peer <i>IP-address</i>	Displays the synchronization status for a peer switch.
show switch-profile <i>name</i> session-history	Displays the status of the last 20 switch profile sessions.
show switch-profile <i>name</i> status	Displays the configuration synchronization status of a peer switch.
show running-config exclude-provision	Displays the configurations for offline preprovisioned interfaces that are hidden.
show running-config switch-profile	Displays the running configuration for the switch profile on the local switch.
show startup-config switch-profile	Displays the startup configuration for the switch profile on the local switch.

Supported Switch Profile Commands

The following switch profile commands are supported:

- **logging event link-status default**
- **[no] vlan** *vlan-range*
- **ip access-list** *acl-name*
- **policy-map type network-qos jumbo-frames**
 - **class type network-qos class-default**
 - **mtu** *mtu value*
- **system qos**
 - **service-policy type network-qos jumbo-frames**
- **vlan configuration** *vlan id*
 - **ip igmp snooping querier** *ip*
- **spanning-tree port type edge default**
- **spanning-tree port type edge bpduguard default**
- **spanning-tree loopguard default**
- **no spanning-tree vlan** *vlan id*

- **port-channel load-balance ethernet source-dest-port**
- **interface port-channel *number***
 - **description *text***
 - **switchport mode trunk**
 - **switchport trunk allowed vlan *vlan list***
 - **spanning-tree port type network**
 - **no negotiate auto**
 - **vpc peer-link**
- **interface port-channel *number***
 - **switchport access vlan *vlan id***
 - **spanning-tree port type edge**
 - **speed 10000**
 - **vpc *number***
- **interface ethernet*x/y***
 - **switchport access vlan *vlanid***
 - **spanning-tree port type edge**
 - **channel-group *number* mode active**
- **service dhcp**
- **ip dhcp relay**
- **ipv6 dhcp relay**
- **storm-control unicast level**

Configuration Examples for Switch Profiles

Creating a Switch Profile on a Local and Peer Switch Example

The following example shows how to create a successful switch profile configuration on a local and peer switch.

Procedure

	Command or Action	Purpose
Step 1	Enable FSoIP distribution on the local and the peer switch.	

	Command or Action	Purpose
	<p>Example: switch# configuration terminal switch(config)# FS ipv4 distribute</p>	
Step 2	<p>Create a switch profile on the local and the peer switch.</p> <p>Example: switch(config-sync)# switch-profile abc switch(config-sync-sp)# sync-peers destination 10.1.1.1</p>	
Step 3	<p>Verify that the switch profiles are the same on the local and the peer switch.</p> <p>Example: switch(config-sync-sp)# show switch-profile abc status Start-time: 15801 usecs after Mon Aug 23 06:21:08 2017 End-time: 6480 usecs after Mon Aug 23 06:21:13 2017 Profile-Revision: 1 Session-type: Initial-Exchange Peer-triggered: Yes Profile-status: Sync Success Local information: ----- Status: Commit Success Error(s): Peer information: ----- IP-address: 10.1.1.1 Sync-status: In Sync. Status: Commit Success Error(s):</p>	
Step 4	<p>Add the configuration commands to the switch profile on the local switch. The commands will be applied to the peer switch when the commands are committed.</p> <p>Example: switch(config-sync-sp)# class-map type qos c1</p>	
Step 5	<p>Verify the commands in the switch profile.</p> <p>Example: switch(config-sync-sp-if)# verify Verification Successful</p>	
Step 6	<p>Apply the commands to the switch profile and to synchronize the configurations between the local and the peer switch.</p> <p>Example: switch(config-sync-sp)# commit Commit Successful switch(config-sync)#</p>	

Verifying the Synchronization Status Example

The following example shows how to verify the synchronization status between the local and the peer switch:

```
switch(config-sync)# show switch-profile switch-profile status
Start-time: 804935 usecs after Mon Oct 02 06:41:10 2017
End-time: 956631 usecs after Mon Oct 02 06:41:20 2017

Profile-Revision: 2
Session-type: Commit
Peer-triggered: No
Profile-status: Sync Success

Local information:
-----
Status: Commit
Success Error(s):

Peer information:
-----
IP-address: 10.1.1.1
Sync-status: In Sync.
Status: Commit
Success Error(s):

switch(config-sync)#
```

Displaying the Running Configuration

The following example shows how to display the running configuration of the switch profile on the local switch:

```
switch# configure sync
switch(config-sync)# show running-config switch-profile

switch(config-sync)#
```

Displaying the Switch Profile Synchronization Between Local and Peer Switches

This example shows how to display the synchronization status for two peer switches:

```
switch1# show switch-profile sp status

Start-time: 491815 usecs after Mon Oct 02 11:54:51 2017
End-time: 449475 usecs after Mon Oct 02 11:54:58 2017

Profile-Revision: 1
Session-type: Initial-Exchange
Peer-triggered: No
Profile-status: Sync Success

Local information:
-----
Status: Commit
Success Error(s):

Peer information:
-----
IP-address: 10.193.194.52
Sync-status: In Sync.
Status: Commit
Success Error(s):
```

```

switch1#

switch2# show switch-profile sp status

Start-time: 503194 usecs after Mon Oct 02 11:54:51 2017
End-time: 532989 usecs after Mon Oct 02 11:54:58 2017
Profile-Revision: 1
Session-type: Initial-Exchange
Peer-triggered: Yes
Profile-status: Sync Success

Local information:
-----
Status: Commit Success
Error(s):

Peer information:
-----
IP-address: 10.193.194.51
Sync-status: In Sync.
Status: Commit Success
Error(s):

switch2#

```

Displaying Verify and Commit on Local and Peer Switches

This example shows how to configure a successful verify and commit of the local and peer switch:

```

switch1# configure sync

Enter configuration commands, one per line. End with CNTL/Z.
switch1(config-sync)# switch-profile sp
Switch-Profile started, Profile ID is 1
switch1(config-sync-sp)# interface ethernet1/1
switch1(config-sync-sp-if)# description foo
switch1(config-sync-sp-if)# verify
Verification Successful
switch1(config-sync-sp)# commit
Commit Successful
switch1(config-sync)# show running-config switch-profile
switch-profile sp
  sync-peers destination
  10.193.194.52 interface Ethernet1/1
  description foo
switch1(config-sync)# show switch-profile sp status

Start-time: 171513 usecs after Mon Oct 02 17:51:28 2017
End-time: 676451 usecs after Mon Oct 02 17:51:43 2017
Profile-Revision: 3
Session-type: Commit
Peer-triggered: No
Profile-status: Sync Success

Local information:
-----
Status: Commit Success
Error(s):

Peer information:
-----
IP-address: 10.193.194.52
Sync-status: In Sync.
Status: Commit Success
Error(s):

switch1(config-sync)#

```



```

switch2# show running-config switch-profile
switch-profile sp
  sync-peers destination 10.193.194.51
  interface Ethernet1/1
    description foo
switch2# show switch-profile sp status
Start-time: 265716 usecs after Mon Oct 02 16:51:28 2017
End-time: 734702 usecs after Mon Oct 02 16:51:43 2017

Profile-Revision: 3
Session-type: Commit
Peer-triggered: Yes
Profile-status: Sync Success

Local information:
-----
Status: Commit
Success Error(s):
Peer information:
-----
IP-address: 10.193.194.51
Sync-status: In Sync.
Status: Commit
Success Error(s):
switch2#

```

Successful and Unsuccessful Synchronization Examples

The following example shows a successful synchronization of the switch profile on the peer switch:

```

switch# show switch-profile abc peer

switch# show switch-profile sp peer 10.193.194.52
Peer-sync-status      : In Sync.
Peer-status           : Commit Success
Peer-error(s)        :
switch1#

```

The following example shows an unsuccessful synchronization of a switch profile on the peer switch, with a peer not reachable status:

```

switch# show switch-profile sp peer 10.193.194.52

Peer-sync-status      : Not yet merged. pending-merge:1 received_merge:0
Peer-status           : Peer not reachable
Peer-error(s)        :
switch#

```

Configuring the Switch Profile Buffer, Moving the Buffer, and Deleting the Buffer

This example shows how to configure the switch profile buffer, the buffer-move configuration, and the buffer-delete configuration:

```

switch# configure sync
Enter configuration commands, one per line. End with CNTL/Z.
switch(config-sync)# switch-profile sp
Switch-Profile started, Profile ID is 1
switch(config-sync-sp)# vlan 101
switch(config-sync-sp-vlan)# ip igmp snooping querier 10.101.1.1
switch(config-sync-sp-vlan)# exit

```

```
switch(config-sync-sp) # mac address-table static 0000.0000.0001 vlan 101 drop
switch(config-sync-sp) # interface ethernet1/2
switch(config-sync-sp-if) # switchport mode trunk
switch(config-sync-sp-if) # switchport trunk allowed vlan 101
switch(config-sync-sp-if) # exit
switch(config-sync-sp) # show switch-profile sp buffer
-----
Seq-no  Command
-----
1      vlan 101
1.1    ip igmp snooping querier 10.101.1.1
2      mac address-table static 0000.0000.0001 vlan 101 drop
3      interface Ethernet1/2
3.1    switchport mode trunk
3.2    switchport trunk allowed vlan 101
switch(config-sync-sp) # buffer-move 3 1
switch(config-sync-sp) # show switch-profile sp buffer
-----
Seq-no  Command
-----
1      interface Ethernet1/2
1.1    switchport mode trunk
1.2    switchport trunk allowed vlan 101
2      vlan 101
2.1    ip igmp snooping querier 10.101.1.1
3      mac address-table static 0000.0000.0001 vlan 101 drop
switch(config-sync-sp) # buffer-delete 1
switch(config-sync-sp) # show switch-profile sp buffer
-----
Seq-no  Command
-----
2      vlan 101
2.1    ip igmp snooping querier 10.101.1.1
3      mac address-table static 0000.0000.0001 vlan 101 drop
switch(config-sync-sp) # buffer-delete all
switch(config-sync-sp) # show switch-profile sp buffer
switch(config-sync-sp) #
```

Using Fabric Services

This chapter contains the following sections:

- [Information About FS, page 31](#)
- [FS Distribution, page 32](#)
- [FS Support for Applications, page 33](#)
- [FS Regions, page 36](#)
- [Configuring FS over IP, page 39](#)
- [Default Settings for FS, page 40](#)

Information About FS

Some features in the Inspur CN6000Series switch require configuration synchronization with other switches in the network to function correctly. Synchronization through manual configuration at each switch in the network can be a tedious and error-prone process.

Fabric Services (FS) provides a common infrastructure for automatic configuration synchronization in the network. It provides the transport function and a set of common services to the features. FS has the ability to discover FS-capable switches in the network and to discover feature capabilities in all FS-capable switches.

Inspur CN6000Series switches support FS message distribution over IPv4 or IPv6 networks.

FS provides the following features:

- Peer-to-peer protocol with no client-server relationship at the FS layer.
- Three modes of distribution.
 - Coordinated distributions—Only one distribution is allowed in the network at any given time.
 - Uncoordinated distributions—Multiple parallel distributions are allowed in the network except when a coordinated distribution is in progress.

- Unrestricted uncoordinated distributions—Multiple parallel distributions are allowed in the network in the presence of an existing coordinated distribution. Unrestricted uncoordinated distributions are allowed to run in parallel with all other types of distributions.

The following features are supported for FS distribution over IP:

- One scope of distribution over an IP network:
 - Physical scope—The distribution spans the entire IP network.

FS Distribution

The FS distribution functionality is independent of the lower layer transport. Inspur CN6000 Series switches support FS distribution over IP. Features that use FS are unaware of the lower layer transport.

FS Distribution Modes

FS supports three distribution modes to accommodate different feature requirements:

- Uncoordinated Distribution
- Coordinated Distribution
- Unrestricted Uncoordinated Distributions

Only one mode is allowed at any given time.

Uncoordinated Distribution

Uncoordinated distributions are used to distribute information that is not expected to conflict with information from a peer. Parallel uncoordinated distributions are allowed for a feature.

Coordinated Distribution

Coordinated distributions allow only one feature distribution at a given time. FS uses locks to enforce this feature. A coordinated distribution is not allowed to start if locks are taken for the feature anywhere in the network. A coordinated distribution consists of three stages:

- A network lock is acquired.
- The configuration is distributed and committed.
- The network lock is released.

Coordinated distribution has two variants:

- FS driven —The stages are executed by FS in response to a feature request without intervention from the feature.
- Feature driven—The stages are under the complete control of the feature.

Coordinated distributions are used to distribute information that can be manipulated and distributed from multiple switches, for example, the port security configuration.

Unrestricted Uncoordinated Distributions

Unrestricted uncoordinated distributions allow multiple parallel distributions in the network in the presence of an existing coordinated distribution. Unrestricted uncoordinated distributions are allowed to run in parallel with all other types of distributions.

Verifying the FS Distribution Status

The **show FS status** command displays the status of FS distribution on the switch:

```
switch# show FS status
Distribution : Enabled
Distribution over IP : Enabled - mode IPv4
IPv4 multicast address : 239.255.70.83
Distribution over Ethernet : Enabled
```

FS Support for Applications

FS Application Requirements

All switches in the network must be FS capable. Switches that are not FS capable do not receive distributions, which results in part of the network not receiving the intended distribution. FS has the following requirements:

- Implicit FS usage—The first time that you issue a FS task for a FS-enabled application, the configuration modification process begins and the application locks the network.
- Pending database—The pending database is a temporary buffer to hold uncommitted information. The uncommitted changes are not applied immediately to ensure that the database is synchronized with the

database in the other switches in the network. When you commit the changes, the pending database overwrites the configuration database (also known as the active database or the effective database).

- FS distribution enabled or disabled on a per-application basis—The default (enable or disable) for the FS distribution state differs between applications. If FS distribution is disabled for an application, that application does not distribute any configuration and does not accept a distribution from other switches in the network.
- Explicit FS commit—Most applications require an explicit commit operation to copy the changes in the temporary buffer to the application database, to distribute the new database to the network, and to release the network lock. The changes in the temporary buffer are not applied if you do not perform the commit operation.

Enabling FS for an Application

All FS-based applications provide an option to enable or disable the distribution capabilities.

Applications have the distribution enabled by default.

The application configuration is not distributed by FS unless distribution is explicitly enabled for that application.

Verifying Application Registration Status

The **show FS application** command displays the applications that are currently registered with FS. The first column displays the application name. The second column indicates whether the application is enabled or disabled for distribution (enabled or disabled). The last column indicates the scope of distribution for the application (logical, physical, or both).



Note

The **show FS application** command only displays applications registered with FS. Conditional services that use FS do not appear in the output unless these services are running.

```
switch# show FS application
-----
Application      Enabled      Scope
-----
ntp              No          Physical-all
fscm             Yes         Physical-fc
rscn             No          Logical
fctimer         No          Physical-fc
syslogd         No          Physical-all
callhome        No          Physical-all
fcdomain        Yes         Logical
device-alias    Yes         Physical-fc
Total number of entries = 8
```

The **show FS application name** command displays the details for a particular application. It displays the enabled/disabled state, timeout as registered with FS, merge capability (if it has registered with FS for merge support), and the distribution scope.

```
switch# show FS application name fscm
```

```
Enabled          : Yes
Timeout          : 100s
Merge Capable   : No
Scope           : Physical-fc
```

Locking the Network

When you configure (first-time configuration) a feature (application) that uses the FS infrastructure, that feature starts a FS session and locks the network. When a network is locked, the switch software allows configuration changes to this feature only from the switch that holds the lock. If you make configuration changes to the feature from another switch, the switch issues a message to inform the user about the locked status. The configuration changes are held in a pending database by that application.

If you start a FS session that requires a network lock but forget to end the session, an administrator can clear the session. If you lock a network at any time, your username is remembered across restarts and switchovers. If another user (on the same machine) tries to perform configuration tasks, that user's attempts are rejected.

Verifying FS Lock Status

The **show FS lock** command displays all the locks that are currently acquired by any application. For each application the command displays the application name and scope of the lock taken.

The **show FS lock name** command displays the lock details for the specified application.

Committing Changes

A commit operation saves the pending database for all application peers and releases the lock for all switches.

The commit function does not start a session; only a lock function starts a session. However, an empty commit is allowed if configuration changes are not previously made. In this case, a commit operation results in a session that acquires locks and distributes the current database.

When you commit configuration changes to a feature using the FS infrastructure, you receive a notification about one of the following responses:

- One or more external switches report a successful status—The application applies the changes locally and releases the network lock.
- None of the external switches report a successful state—The application considers this state a failure and does not apply the changes to any switch in the network. The network lock is not released.

You can commit changes for a specified feature by entering the **commit** command for that feature.

Discarding Changes

If you discard configuration changes, the application flushes the pending database and releases locks in the network. Both the abort and commit functions are supported only from the switch from which the network lock is acquired.

You can discard changes for a specified feature by using the **abort** command for that feature.

Saving the Configuration

Configuration changes that have not been applied yet (still in the pending database) are not shown in the running configuration. The configuration changes in the pending database overwrite the configuration in the effective database when you commit the changes.



Caution If you do not commit the changes, they are not saved to the running configuration.

Clearing a Locked Session

You can clear locks held by an application from any switch in the network to recover from situations where locks are acquired and not released. This function requires Admin permissions.



Caution Exercise caution when using this function to clear locks in the network. Any pending configurations in any switch in the network is flushed and lost.

FS Regions

About FS Regions

A FS region is a user-defined subset of switches for a given feature or application in its physical distribution scope. When a network spans a vast geography, you might need to localize or restrict the distribution of certain profiles among a set of switches based on their physical proximity. FS regions allow you to create multiple islands of distribution within the network for a given FS feature or application. FS regions are designed to restrict the distribution of a feature's configuration to a specific set or grouping of switches in a network.

Example Scenario

The Smart Call Home application triggers alerts to network administrators when a situation arises or something abnormal occurs. When the network covers many geographies, and there are multiple network administrators who are each responsible for a subset of switches in the network, the Smart Call Home application sends alerts to all network administrators regardless of their location. For the Smart Call Home application to send message alerts selectively to network administrators, the physical scope of the application has to be fine tuned or narrowed down. You can achieve this scenario by implementing FS regions.

FS regions are identified by numbers ranging from 0 through 200. Region 0 is reserved as the default region and contains every switch in the network. You can configure regions from 1 through 200. The default region maintains backward compatibility.

If the feature is moved, that is, assigned to a new region, its scope is restricted to that region; it ignores all other regions for distribution or merging purposes. The assignment of the region to a feature has precedence in distribution over its initial physical scope.

You can configure a FS region to distribute configurations for multiple features. However, on a given switch, you can configure only one FS region at a time to distribute the configuration for a given feature. Once you assign a feature to a FS region, its configuration cannot be distributed within another FS region.

Managing FS Regions

Creating FS Regions

You can create a FS region.

Procedure

	Command or Action	Purpose
Step 1	switch# configure terminal	Enters global configuration mode.
Step 2	switch(config)# FS region <i>region-id</i>	Creates a region.

Assigning Applications to FS Regions

You can assign an application on a switch to a region.

Procedure

	Command or Action	Purpose
Step 1	switch# configure terminal	Enters global configuration mode.
Step 2	switch(config)# FS region <i>region-id</i>	Creates a region.
Step 3	switch(config-FS-region)# <i>application</i>	Adds application(s) to the region. Note You can add any number of applications on the switch to a region. If you try adding an application to the same region more than once, you see the "Application already present in the same region" error message.

The following example shows how to assign applications to a region:

```
switch# configure terminal
switch(config)# FS region 1
switch(config-FS-region)# ntp
switch(config-FS-region)# callhome
```

Moving an Application to a Different FS Region

You can move an application from one region to another region.

Procedure

	Command or Action	Purpose
Step 1	switch# configure terminal	Enters global configuration mode.
Step 2	switch(config)# FS region <i>region-id</i>	Enters FS region configuration submode.
Step 3	switch(config-FS-region)# <i>application</i>	Indicates application(s) to be moved from one region into another. Note If you try moving an application to the same region more than once, you see the "Application already present in the same region" error message.

The following example shows how to move an application into Region 2 that was originally assigned to Region 1:

```
switch# configure terminal
switch(config)# FS region 2
switch(config-FS-region)# ntp
```

Removing an Application from a Region

Removing an application from a region is the same as moving the application back to the default region (Region 0), which brings the entire network into the scope of distribution for the application.

Procedure

	Command or Action	Purpose
Step 1	switch# configure terminal	Enters global configuration mode.
Step 2	switch(config)# FS region <i>region-id</i>	Enters FS region configuration submode.
Step 3	switch(config-FS-region)# no <i>application</i>	Removes application(s) that belong to the region.

Deleting FS Regions

Deleting a region nullifies the region definition. All the applications bound by the region are released back to the default region.

Procedure

	Command or Action	Purpose
Step 1	switch# configure terminal	Enters global configuration mode.
Step 2	switch(config)# no FS region <i>region-id</i>	Deletes the region. Note You see the, "All the applications in the region will be moved to the default region" warning.

Configuring FS over IP

Enabling FS over IPv4

You can enable or disable FS over IPv4.

Procedure

	Command or Action	Purpose
Step 1	switch# configure terminal	Enters global configuration mode.
Step 2	switch(config)# FS ipv4 distribute	Globally enables FS over IPv4 for all applications on the switch.
Step 3	switch(config)# no FS ipv4 distribute	(Optional) Disables (default) FS over IPv4 on the switch.

Verifying the FS Over IP Configuration

The following example show how to verify the FS over IP configuration:

```
switch# show FS status
Distribution : Enabled
Distribution over IP : Enabled - mode IPv4
IPv4 multicast address : 239.255.70.83
```

Configuring IP Multicast Addresses for FS over IP

All FS over IP enabled switches with similar multicast addresses form one FS over IP network. FS protocol-specific distributions, such as the keepalive mechanism for detecting network topology changes, use the IP multicast address to send and receive information.



Note FS distributions for application data use directed unicast.

Configuring IPv4 Multicast Address for FS

You can configure a FS over IP multicast address value for IPv4. The default IPv4 multicast address is 239.255.70.83.

Procedure

	Command or Action	Purpose
Step 1	switch# configure terminal	Enters global configuration mode.
Step 2	switch(config)# FS ipv4 mcast-address ipv4-address	Configures the IPv4 multicast address for FS distribution over IPv4. The ranges of valid IPv4 addresses are 239.255.0.0 through 239.255.255.255 and 239.192/16 through 239.251/16.
Step 3	switch(config)# no FS ipv4 mcast-address ipv4-address	(Optional) Reverts to the default IPv4 multicast address for FS distribution over IPv4. The default IPv4 multicast address for FS is 239.255.70.83.

Verifying the IP Multicast Address Configuration for FS over IP

The following example shows how to verify the IP multicast address configuration for FS over IP:

```
switch# show FS status
Fabric distribution Enabled
IP distribution Enabled mode ipv4
IPv4 multicast address : 10.1.10.100
```

Default Settings for FS

The following table lists the default settings for FS configurations.

Table 1: Default FS Parameters

Parameters	Default
FS distribution on the switch	Enabled
Database changes	Implicitly enabled with the first configuration change
Application distribution	Differs based on application

Parameters	Default
Commit	Explicit configuration is required
FS over IP	Disabled
IPv4 multicast address	239.255.70.83

Configuring NTP

This chapter contains the following sections:

- [Information About NTP, page 43](#)
- [NTP as Time Server, page 44](#)
- [Distributing NTP Using FS, page 44](#)
- [Clock Manager, page 44](#)
- [High Availability, page 44](#)
- [Virtualization Support, page 45](#)
- [Licensing Requirements, page 45](#)
- [Prerequisites for NTP, page 45](#)
- [Guidelines and Limitations for NTP, page 45](#)
- [Default Settings, page 46](#)
- [Configuring NTP, page 47](#)
- [Verifying the NTP Configuration, page 58](#)
- [Configuration Examples for NTP, page 59](#)

Information About NTP

The Network Time Protocol (NTP) synchronizes the time of day among a set of distributed time servers and clients so that you can correlate events when you receive system logs and other time-specific events from multiple network devices. NTP uses the User Datagram Protocol (UDP) as its transport protocol. All NTP communications use Coordinated Universal Time (UTC).

An NTP server usually receives its time from an authoritative time source, such as a radio clock or an atomic clock attached to a time server, and then distributes this time across the network. NTP is extremely efficient; no more than one packet per minute is necessary to synchronize two machines to within a millisecond of each other.

NTP uses a stratum to describe the distance between a network device and an authoritative time source:

- A stratum 1 time server is directly attached to an authoritative time source (such as a radio or atomic clock or a GPS time source).
- A stratum 2 NTP server receives its time through NTP from a stratum 1 time server.

Before synchronizing, NTP compares the time reported by several network devices and does not synchronize with one that is significantly different, even if it is a stratum 1. Because Inspur INOS-CN cannot connect to a radio or atomic clock and act as a stratum 1 server, we recommend that you use the public NTP servers available on the Internet. If the network is isolated from the Internet, Inspur INOS-CN allows you to configure the time as though it were synchronized through NTP, even though it was not.

**Note**

You can create NTP peer relationships to designate the time-serving hosts that you want your network device to consider synchronizing with and to keep accurate time if a server failure occurs.

The time kept on a device is a critical resource, so we strongly recommend that you use the security features of NTP to avoid the accidental or malicious setting of incorrect time. Two mechanisms are available: an access list-based restriction scheme and an encrypted authentication mechanism.

NTP as Time Server

Other devices can configure it as a time server. You can also configure the device to act as an authoritative NTP server, enabling it to distribute time even when it is not synchronized to an outside time source.

Distributing NTP Using FS

Fabric Services (FS) distributes the local NTP configuration to all Inspur devices in the network.

After enabling FS on your device, a network-wide lock is applied to NTP whenever an NTP configuration is started. After making the NTP configuration changes, you can discard or commit them.

In either case, the FS lock is then released from the NTP application.

Clock Manager

Clocks are resources that need to be shared across different processes.

Multiple time synchronization protocols, such as NTP and Precision Time Protocol (PTP), might be running in the system.

High Availability

Stateless restarts are supported for NTP. After a reboot or a supervisor switchover, the running configuration is applied.

You can configure NTP peers to provide redundancy in case an NTP server fails.

Virtualization Support

NTP recognizes virtual routing and forwarding (VRF) instances. NTP uses the default VRF if you do not configure a specific VRF for the NTP server and NTP peer.

Licensing Requirements

Product	License Requirement
Inspur INOS-CN	NTP requires no license. Any feature not included in a license package is bundled with the Inspur INOS-CN image and is provided at no extra charge to you.

Prerequisites for NTP

NTP has the following prerequisites:

- To configure NTP, you must have connectivity to at least one server that is running NTP.

Guidelines and Limitations for NTP

NTP has the following configuration guidelines and limitations:

- The **show ntp session status** CLI command does not show the last action time stamp, the last action, the last action result, and the last action failure reason.
- NTP server functionality is supported.
- You should have a peer association with another device only when you are sure that your clock is reliable (which means that you are a client of a reliable NTP server).
- A peer configured alone takes on the role of a server and should be used as a backup. If you have two servers, you can configure several devices to point to one server and the remaining devices to point to the other server. You can then configure a peer association between these two servers to create a more reliable NTP configuration.
- If you have only one server, you should configure all the devices as clients to that server.
- You can configure up to 64 NTP entities (servers and peers).
- If FS is disabled for NTP, NTP does not distribute any configuration and does not accept a distribution from other devices in the network.

- After FS distribution is enabled for NTP, the entry of an NTP configuration command locks the network for NTP configuration until a **commit** command is entered. During the lock, no changes can be made to the NTP configuration by any other device in the network except the device that initiated the lock.
- If you use FS to distribute NTP, all devices in the network should have the same VRFs configured as you use for NTP.
- If you configure NTP in a VRF, ensure that the NTP server and peers can reach each other through the configured VRFs.
- You must manually distribute NTP authentication keys on the NTP server and Inspur INOS-CN devices across the network.
- Use NTP broadcast or multicast associations when time accuracy and reliability requirements are modest, your network is localized, and the network has more than 20 clients. We recommend that you use NTP broadcast or multicast associations in networks that have limited bandwidth, system memory, or CPU resources.
- A maximum of four ACLs can be configured for a single NTP access group.



Note Time accuracy is marginally reduced in NTP broadcast associations because information flows only one way.

Default Settings

The following are the default settings for NTP parameters.

Parameters	Default
NTP	Enabled for all interfaces
NTP passive (enabling NTP to form associations)	Enabled
NTP authentication	Disabled
NTP access	Enabled
NTP access group match all	Disabled
NTP broadcast server	Disabled
NTP multicast server	Disabled
NTP multicast client	Disabled
NTP logging	Disabled

Configuring NTP

Enabling or Disabling NTP on an Interface

You can enable or disable NTP on a particular interface. NTP is enabled on all interfaces by default.

Procedure

	Command or Action	Purpose
Step 1	switch# configure terminal	Enters global configuration mode.
Step 2	switch(config)# interface <i>type slot/port</i>	Enters interface configuration mode.
Step 3	switch(config-if)# [no] ntp disable {ip ipv6}	Disables NTP IPv4 or IPv6 on the specified interface. Use the no form of this command to reenable NTP on the interface.
Step 4	switch(config-if)# copy running-config startup-config	(Optional) Saves the change persistently through reboots and restarts by copying the running configuration to the startup configuration.

The following example shows how to enable or disable NTP on an interface:

```
switch# configure terminal
switch(config)# interface ethernet 6/1
switch(config-if)# ntp disable ip
switch(config-if)# copy running-config startup-config
```

Configuring the Device as an Authoritative NTP Server

You can configure the device to act as an authoritative NTP server, enabling it to distribute time even when it is not synchronized to an existing time server.

Procedure

	Command or Action	Purpose
Step 1	switch# configure terminal	Enters global configuration mode.
Step 2	[no] ntp master [<i>stratum</i>]	Configures the device as an authoritative NTP server. You can specify a different stratum level from which NTP clients get their time synchronized. The range is from 1 to 15.

	Command or Action	Purpose
Step 3	<code>show running-config ntp</code>	(Optional) Displays the NTP configuration.
Step 4	<code>switch(config)# copy running-config startup-config</code>	(Optional) Saves the change persistently through reboots and restarts by copying the running configuration to the startup configuration.

This example shows how to configure the Inspur INOS-CN device as an authoritative NTP server with a different stratum level:

```
switch# configure terminal
```

Enter configuration commands, one per line. End with CNTL/Z.

```
switch(config)# ntp master 5
```

Configuring an NTP Server and Peer

You can configure an NTP server and peer.

Before You Begin

Make sure that you know the IP address or DNS names of your NTP server and its peers.

Procedure

	Command or Action	Purpose
Step 1	<code>switch# configure terminal</code>	Enters global configuration mode.
Step 2	<code>switch(config)# [no] ntp server {ip-address ipv6-address dns-name} [key key-id] [maxpoll max-poll] [minpoll min-poll] [prefer] [use-vrf vrf-name]</code>	Forms an association with a server. Use the key keyword to configure a key to be used while communicating with the NTP server. The range for the <i>key-id</i> argument is from 1 to 65535. Use the maxpoll and minpoll keywords to configure the maximum and minimum intervals in which to poll a peer. The range for the <i>max-poll</i> and <i>min-poll</i> arguments is from 4 to 16 seconds, and the default values are 6 and 4, respectively. Use the prefer keyword to make this the preferred NTP server for the device. Use the use-vrf keyword to configure the NTP server to communicate over the specified VRF. The <i>vrf-name</i> argument can be default, management, or any case-sensitive alphanumeric string up to 32 characters. Note If you configure a key to be used while communicating with the NTP server, make sure that the key exists as a trusted key on the device.

	Command or Action	Purpose
Step 3	switch(config)# [no] ntp peer { <i>ip-address</i> <i>ipv6-address</i> <i>dns-name</i> } [key <i>key-id</i>] [maxpoll <i>max-poll</i>] [minpoll <i>min-poll</i>] [prefer] [use-vrf <i>vrf-name</i>]	<p>Forms an association with a peer. You can specify multiple peer associations.</p> <p>Use the key keyword to configure a key to be used while communicating with the NTP peer. The range for the <i>key-id</i> argument is from 1 to 65535.</p> <p>Use the maxpoll and minpoll keywords to configure the maximum and minimum intervals in which to poll a peer. The range for the <i>max-poll</i> and <i>min-poll</i> arguments is from 4 to 17 seconds, and the default values are 6 and 4, respectively.</p> <p>Use the prefer keyword to make this the preferred NTP peer for the device.</p> <p>Use the use-vrf keyword to configure the NTP peer to communicate over the specified VRF. The <i>vrf-name</i> argument can be default, management, or any case-sensitive alphanumeric string up to 32 characters.</p>
Step 4	switch(config)# show ntp peers	<p>(Optional)</p> <p>Displays the configured server and peers.</p> <p>Note A domain name is resolved only when you have a DNS server configured.</p>
Step 5	switch(config)# copy running-config startup-config	<p>(Optional)</p> <p>Saves the change persistently through reboots and restarts by copying the running configuration to the startup configuration.</p>

Configuring NTP Authentication

You can configure the device to authenticate the time sources to which the local clock is synchronized. When you enable NTP authentication, the device synchronizes to a time source only if the source carries one of the authentication keys specified by the **ntp trusted-key** command. The device drops any packets that fail the authentication check and prevents them from updating the local clock. NTP authentication is disabled by default.

Before You Begin

Authentication for NTP servers and NTP peers is configured on a per-association basis using the **key** keyword on each **ntp server** and **ntp peer** command. Make sure that you configured all NTP server and peer associations with the authentication keys that you plan to specify in this procedure. Any **ntp server** or **ntp peer** commands that do not specify the **key** keyword will continue to operate without authentication.

Procedure

	Command or Action	Purpose
Step 1	switch# configure terminal	Enters global configuration mode.
Step 2	switch(config)# [no] ntp authentication-key number md5 md5-string	Defines the authentication keys. The device does not synchronize to a time source unless the source has one of these authentication keys and the key number is specified by the ntp trusted-key number command.
Step 3	switch(config)# show ntp authentication-keys	(Optional) Displays the configured NTP authentication keys.
Step 4	switch(config)# [no] ntp trusted-key number	Specifies one or more keys (defined in Step 2) that an unconfigured remote symmetric, broadcast, and multicast time source must provide in its NTP packets in order for the device to synchronize to it. The range for trusted keys is from 1 to 65535. This command provides protection against accidentally synchronizing the device to a time source that is not trusted. This command does not affect time sources configured with the ntp server and ntp peer configuration comments.
Step 5	switch(config)# show ntp trusted-keys	(Optional) Displays the configured NTP trusted keys.
Step 6	switch(config)# [no] ntp authenticate	Enables or disables the NTP authentication feature. NTP authentication is disabled by default.
Step 7	switch(config)# show ntp authentication-status	(Optional) Displays the status of NTP authentication.
Step 8	switch(config)# copy running-config startup-config	(Optional) Saves the change persistently through reboots and restarts by copying the running configuration to the startup configuration.

This example shows how to configure the device to synchronize only to time sources that provide authentication key 42 in their NTP packets:

```
switch# configure terminal
Enter configuration commands, one per line. End with CNTL/Z.
switch(config)# ntp authentication-key 42 md5 aNiceKey
switch(config)# ntp server 10.1.1.1 key 42
switch(config)# ntp trusted-key 42
switch(config)# ntp authenticate
switch(config)# copy running-config startup-config
[#####]
100% switch(config)#
```

Configuring NTP Access Restrictions

You can control access to NTP services by using access groups. Specifically, you can specify the types of requests that the device allows and the servers from which it accepts responses.

If you do not configure any access groups, NTP access is granted to all devices. If you configure any access groups, NTP access is granted only to the remote device whose source IP address passes the access list criteria.

Procedure

	Command or Action	Purpose
Step 1	switch# configure terminal	Enters global configuration mode.
Step 2	switch(config)# [no] ntp access-group match-all { {peer serve serve-only query-only }access-list-name }	<p>Creates or removes an access group to control NTP access and applies a basic IP access list.</p> <p>The access group options are scanned in the following order, from least restrictive to most restrictive. However, if NTP matches a deny ACL rule in a configured peer, ACL processing stops and does not continue to the next access group option.</p> <ul style="list-style-type: none"> • The peer keyword enables the device to receive time requests and NTP control queries and to synchronize itself to the servers specified in the access list. • The serve keyword enables the device to receive time requests and NTP control queries from the servers specified in the access list but not to synchronize itself to the specified servers. • The serve-only keyword enables the device to receive only time requests from servers specified in the access list. • The query-only keyword enables the device to receive only NTP control queries from the servers specified in the access list. • The match-all keyword enables the access group options to be scanned in the following order, from least restrictive to most restrictive: peer, serve, serve-only, query-only. If the incoming packet does not match the ACL in the peer access group, it goes to the serve access group to be processed. If the packet does not match the ACL in the serve access group, it goes to the serve-only access group, and so on.
Step 3	switch(config)# show ntp access-groups	(Optional) Displays the NTP access group configuration.

	Command or Action	Purpose
Step 4	switch(config)# copy running-config startup-config	(Optional) Saves the change persistently through reboots and restarts by copying the running configuration to the startup configuration.

This example shows how to configure the device to allow it to synchronize to a peer from access

group "accesslist1":

```
switch# configure terminal
switch(config)# ntp access-group peer accesslist1
switch(config)# show ntp access-groups
Access List Type
-----
accesslist1 Peer
switch(config)# copy running-config startup-config
[#####]
100% switch(config)#
```

Configuring the NTP Source IP Address

NTP sets the source IP address for all NTP packets based on the address of the interface through which the NTP packets are sent. You can configure NTP to use a specific source IP address.

Procedure

	Command or Action	Purpose
Step 1	switch# configure terminal	Enters global configuration mode.
Step 2	[no] ntp source ip-address	Configures the source IP address for all NTP packets. The <i>ip-address</i> can be in IPv4 or IPv6 format.

This example shows how to configure an NTP source IP address of 192.0.2.2.

```
switch# configure terminal
switch(config)# ntp source 192.0.2.2
```

Configuring the NTP Source Interface

You can configure NTP to use a specific interface.

Procedure

	Command or Action	Purpose
Step 1	switch# configure terminal	Enters global configuration mode.
Step 2	[no] ntp source-interface interface	Configures the source interface for all NTP packets. The following list contains the valid values for <i>interface</i> .

	Command or Action	Purpose
		<ul style="list-style-type: none"> • ethernet • loopback • mgmt • port-channel • vlan

This example shows how to configure the NTP source interface:

```
switch# configure terminal
switch(config)# ntp source-interface ethernet
```

Configuring an NTP Broadcast Server

You can configure an NTP IPv4 broadcast server on an interface. The device then sends broadcast packets through that interface periodically. The client is not required to send a response.

Procedure

	Command or Action	Purpose
Step 1	switch# configure terminal	Enters global configuration mode.
Step 2	switch(config)# interface <i>type slot/port</i>	Enters interface configuration mode.
Step 3	switch(config-if)# [no] ntp broadcast [destination <i>ip-address</i>] [key <i>key-id</i>] [version <i>number</i>]	<p>Enables an NTP IPv4 broadcast server on the specified interface.</p> <ul style="list-style-type: none"> • destination <i>ip-address</i>—Configures the broadcast destination IP address. • key <i>key-id</i>—Configures the broadcast authentication key number. The range is from 1 to 65535. • version <i>number</i>—Configures the NTP version. The range is from 2 to 4.
Step 4	switch(config-if)# exit	Exits interface configuration mode.
Step 5	switch(config)# [no] ntp broadcastdelay <i>delay</i>	(Optional) Configures the estimated broadcast round-trip delay in microseconds. The range is from 1 to 999999.

	Command or Action	Purpose
Step 6	switch(config)# copy running-config startup-config	(Optional) Saves the change persistently through reboots and restarts by copying the running configuration to the startup configuration.

This example shows how to configure an NTP broadcast server:

```
switch# configure terminal
switch(config)# interface ethernet 6/1
switch(config-if)# ntp broadcast destination 192.0.2.10
switch(config-if)# exit
switch(config)# ntp broadcastdelay 100
switch(config)# copy running-config startup-config
```

Configuring an NTP Multicast Server

You can configure an NTP IPv4 or IPv6 multicast server on an interface. The device then sends multicast packets through that interface periodically.

Procedure

	Command or Action	Purpose
Step 1	switch# configure terminal	Enters global configuration mode.
Step 2	switch(config)# interface type slot/port	Enters interface configuration mode.
Step 3	switch(config-if)# [no] ntp multicast [ipv4-address ipv6-address] [key key-id] [ttl value] [version number]	Enables an NTP IPv4 or IPv6 multicast server on the specified interface. <ul style="list-style-type: none"> • <i>ipv4-address</i> or <i>ipv6-address</i>— Multicast IPv4 or IPv6 address. • key key-id—Configures the broadcast authentication key number. The range is from 1 to 65535. • <i>ttl value</i>—Time-to-live value of the multicast packets. The range is from 1 to 255. • <i>version number</i>—NTP version. The range is from 2 to 4.
Step 4	switch(config-if)# copy running-config startup-config	(Optional) Saves the change persistently through reboots and restarts by copying the running configuration to the startup configuration.

This example shows how to configure an Ethernet interface to send NTP multicast packets:

```
switch# configure terminal
switch(config)# interface ethernet 2/2
switch(config-if)# ntp multicast FF02::1:FF0E:8C6C
switch(config-if)# copy running-config startup-config
```

Configuring an NTP Multicast Client

You can configure an NTP multicast client on an interface. The device then listens to NTP multicast messages and discards any messages that come from an interface for which multicast is not configured.

Procedure

	Command or Action	Purpose
Step 1	switch# configure terminal	Enters global configuration mode.
Step 2	switch(config)# interface type slot/port	Enters interface configuration mode.
Step 3	switch(config-if)# [no] ntp multicast client [ipv4-address ipv6-address]	Enables the specified interface to receive NTP multicast packets.
Step 4	switch(config-if)# copy running-config startup-config	(Optional) Saves the change persistently through reboots and restarts by copying the running configuration to the startup configuration.

This example shows how to configure an Ethernet interface to receive NTP multicast packets:

```
switch# configure terminal
switch(config)# interface ethernet 2/3
switch(config-if)# ntp multicast client FF02::1:FF0E:8C6C
switch(config-if)# copy running-config startup-config
```

Configuring NTP Logging

You can configure NTP logging in order to generate system logs with significant NTP events. NTP logging is disabled by default.

Procedure

	Command or Action	Purpose
Step 1	switch# configure terminal	Enters global configuration mode.
Step 2	switch(config)# [no] ntp logging	Enables or disables system logs to be generated with significant NTP events. NTP logging is disabled by default.

	Command or Action	Purpose
Step 3	switch(config)# show ntp logging-status	(Optional) Displays the NTP logging configuration status.
Step 4	switch(config)# copy running-config startup-config	(Optional) Saves the change persistently through reboots and restarts by copying the running configuration to the startup configuration.

The following example shows how to enable NTP logging in order to generate system logs with significant NTP events:

```
switch# configure terminal
switch(config)# ntp logging
switch(config)# copy running-config startup-config
[#####]
100%
switch(config)#
```

Enabling FS Distribution for NTP

You can enable FS distribution for NTP in order to distribute the NTP configuration to other FS-enabled devices.

Before You Begin

Make sure that you have enabled FS distribution for the device.

Procedure

	Command or Action	Purpose
Step 1	switch# configure terminal	Enters global configuration mode.
Step 2	switch(config)# [no] ntp distribute	Enables or disables the device to receive NTP configuration updates that are distributed through FS.
Step 3	switch(config)# show ntp status	(Optional) Displays the NTP FS distribution status.
Step 4	switch(config)# copy running-config startup-config	(Optional) Saves the change persistently through reboots and restarts by copying the running configuration to the startup configuration.

This example shows how to enable the device to receive NTP configuration updates through FS:

```
switch# configure terminal
switch(config)# ntp distribute
switch(config)# copy running-config startup-config
```

Committing NTP Configuration Changes

When you commit the NTP configuration changes, the effective database is overwritten by the configuration changes in the pending database and all the devices in the network receive the same configuration.

Procedure

	Command or Action	Purpose
Step 1	switch# configure terminal	Enters global configuration mode.
Step 2	switch(config)# ntp commit	Distributes the NTP configuration changes to all Inspur INOS-CN devices in the network and releases the FS lock. This command overwrites the effective database with the changes made to the pending database.

Discarding NTP Configuration Changes

After making the configuration changes, you can choose to discard the changes instead of committing them. If you discard the changes, Inspur INOS-CN removes the pending database changes and releases the FS lock.

Procedure

	Command or Action	Purpose
Step 1	switch# configure terminal	Enters global configuration mode.
Step 2	switch(config)# ntp abort	Discards the NTP configuration changes in the pending database and releases the FS lock. Use this command on the device where you started the NTP configuration.

Releasing the FS Session Lock

If you have performed an NTP configuration and have forgotten to release the lock by either committing or discarding the changes, you or another administrator can release the lock from any device in the network. This action also discards pending database changes.

Procedure

	Command or Action	Purpose
Step 1	switch# configure terminal	Enters global configuration mode.

	Command or Action	Purpose
Step 2	switch(config)# clear ntp session	Discards the NTP configuration changes in the pending database and releases the FS lock.

Verifying the NTP Configuration

Command	Purpose
show ntp access-groups	Displays the NTP access group configuration.
show ntp authentication-keys	Displays the configured NTP authentication keys.
show ntp authentication-status	Displays the status of NTP authentication.
show ntp logging-status	Displays the NTP logging status.
show ntp peer-status	Displays the status for all NTP servers and peers.
show ntp peer	Displays all the NTP peers.
show ntp pending	Displays the temporary FS database for NTP.
show ntp pending-diff	Displays the difference between the pending FS database and the current NTP configuration.
show ntp rts-update	Displays the RTS update status.
show ntp session status	Displays the NTP FS distribution session information.
show ntp source	Displays the configured NTP source IP address.
show ntp source-interface	Displays the configured NTP source interface.
show ntp statistics {io local memory peer {ipaddr {ipv4-addr} name peer-name}}	Displays the NTP statistics.
show ntp status	Displays the NTP FS distribution status.
show ntp trusted-keys	Displays the configured NTP trusted keys.
show running-config ntp	Displays NTP information.

Configuration Examples for NTP

Configuration Examples for NTP

This example shows how to configure an NTP server and peer, enable NTP authentication, enable NTP logging, and then save the startup configuration so that it is saved across reboots and restarts:

```
switch# configure terminal

Enter configuration commands, one per line. End with CNTL/Z.
switch(config)# ntp server 192.0.2.105 key 42
switch(config)# ntp peer 192.0.2.105
switch(config)# show ntp peers
-----
Peer IP Address Serv/Peer
-----
192.0.2.100 Peer (configured)
192.0.2.105 Server (configured)
switch(config)# ntp authentication-key 42 md5 aNiceKey
switch(config)# show ntp authentication-keys
-----
Auth key MD5 String
-----
42 aNicekey
switch(config)# ntp trusted-key 42
switch(config)# show ntp trusted-keys
Trusted
Keys: 42
switch(config)# ntp authenticate
switch(config)# show ntp authentication-status
Authentication enabled.
switch(config)# ntp logging
switch(config)# show ntp logging
NTP logging enabled.
switch(config)# copy running-config startup-config
[#####] 100%
switch(config)#
```

This example shows an NTP access group configuration with the following restrictions:

- Peer restrictions are applied to IP addresses that pass the criteria of the access list named “peer-acl.”
- Serve restrictions are applied to IP addresses that pass the criteria of the access list named “serve-acl.”
- Serve-only restrictions are applied to IP addresses that pass the criteria of the access list named “serve-only-acl.”
- Query-only restrictions are applied to IP addresses that pass the criteria of the access list named “query-only-acl.”

```
switch# configure terminal
switch(config)# ntp peer 10.1.1.1
switch(config)# ntp peer 10.2.2.2
switch(config)# ntp peer 10.3.3.3
switch(config)# ntp peer 10.4.4.4
switch(config)# ntp peer 10.5.5.5
switch(config)# ntp peer 10.6.6.6
switch(config)# ntp peer 10.7.7.7
switch(config)# ntp peer 10.8.8.8
switch(config)# ntp access-group peer peer-acl
switch(config)# ntp access-group serve serve-acl
switch(config)# ntp access-group serve-only serve-only-acl
switch(config)# ntp access-group query-only query-only-acl
switch(config)# ip access-list peer-acl
switch(config-acl)# 10 permit ip host 10.1.1.1 any
switch(config-acl)# 20 permit ip host 10.8.8.8 any
```



```
switch(config)# ip access-list serve-acl
switch(config-acl)# 10 permit ip host 10.4.4.4 any
switch(config-acl)# 20 permit ip host 10.5.5.5 any
switch(config)# ip access-list serve-only-acl
switch(config-acl)# 10 permit ip host 10.6.6.6 any
switch(config-acl)# 20 permit ip host 10.7.7.7 any
switch(config)# ip access-list query-only-acl
switch(config-acl)# 10 permit ip host 10.2.2.2 any
switch(config-acl)# 20 permit ip host 10.3.3.3 any
```

Configuring PTP

This chapter contains the following sections:

- [Information About PTP, page 61](#)
- [PTP Device Types, page 62](#)
- [PTP Process, page 62](#)
- [High Availability for PTP, page 63](#)
- [Licensing Requirements for PTP, page 63](#)
- [Guidelines and Limitations for PTP, page 63](#)
- [Default Settings for PTP, page 64](#)
- [Configuring PTP, page 64](#)

Information About PTP

PTP is a time synchronization protocol for nodes distributed across a network. Its hardware timestamp feature provides greater accuracy than other time synchronization protocols such as the Network Time Protocol (NTP).

A PTP system can consist of a combination of PTP and non-PTP devices. PTP devices include ordinary clocks, boundary clocks, and transparent clocks. Non-PTP devices include ordinary network switches, routers, and other infrastructure devices.

PTP is a distributed protocol that specifies how real-time PTP clocks in the system synchronize with each other. These clocks are organized into a master-slave synchronization hierarchy with the grandmaster clock, which is the clock at the top of the hierarchy, determining the reference time for the entire system. Synchronization is achieved by exchanging PTP timing messages, with the members using the timing information to adjust their clocks to the time of their master in the hierarchy. PTP operates within a logical scope called a PTP domain.

PTP Device Types

The following clocks are common PTP devices:

Ordinary clock

Communicates with the network based on a single physical port, similar to an end host. An ordinary clock can function as a grandmaster clock.

Boundary clock

Typically has several physical ports, with each port behaving like a port of an ordinary clock. However, each port shares the local clock, and the clock data sets are common to all ports. Each port decides its individual state, either master (synchronizing other ports connected to it) or slave (synchronizing to a downstream port), based on the best clock available to it through all of the other ports on the boundary clock. Messages that are related to synchronization and establishing the master-slave hierarchy terminate in the protocol engine of a boundary clock and are not forwarded.

Transparent clock

Forwards all PTP messages like an ordinary switch or router but measures the residence time of a packet in the switch (the time that the packet takes to traverse the transparent clock) and in some cases the link delay of the ingress port for the packet. The ports have no state because the transparent clock does not need to synchronize to the grandmaster clock.

There are two kinds of transparent clocks:

End-to-end transparent clock

Measures the residence time of a PTP message and accumulates the times in the correction field of the PTP message or an associated follow-up message.

Peer-to-peer transparent clock

Measures the residence time of a PTP message and computes the link delay between each port and a similarly equipped port on another node that shares the link. For a packet, this incoming link delay is added to the residence time in the correction field of the PTP message or an associated follow-up message.

**Note**

PTP operates only in boundary clock mode. We recommend that you deploy a Grand Master Clock (10 MHz) upstream. The servers contain clocks that require synchronization and are connected to the switch. End-to-end transparent clock and peer-to-peer transparent clock modes are not supported.

PTP Process

The PTP process consists of two phases: establishing the master-slave hierarchy and synchronizing the clocks.

Within a PTP domain, each port of an ordinary or boundary clock follows this process to determine its state:

- Examines the contents of all received announce messages (issued by ports in the master state)
- Compares the data sets of the foreign master (in the announce message) and the local clock for priority, clock class, accuracy, and so on
- Determines its own state as either master or slave

After the master-slave hierarchy has been established, the clocks are synchronized as follows:

- The master sends a synchronization message to the slave and notes the time it was sent.
- The slave receives the synchronization message and notes the time that it was received. For every synchronization message, there is a follow-up message. The number of sync messages should be equal to the number of follow-up messages.
- The slave sends a delay-request message to the master and notes the time it was sent.
- The master receives the delay-request message and notes the time it was received.
- The master sends a delay-response message to the slave. The number of delay request messages should be equal to the number of delay response messages.
- The slave uses these timestamps to adjust its clock to the time of its master.

High Availability for PTP

Stateful restarts are not supported for PTP.

Licensing Requirements for PTP

PTP requires no license. Any feature not included in a license package is bundled with the Inspur INOS-CN image and is provided at no extra charge to you.

Guidelines and Limitations for PTP

- For Inspur CN6000 Series switches, PTP clock correction is expected to be in the 3-digit range, from 100 to 999 nanoseconds.
- PTP operates only in boundary clock mode. End-to-end transparent clock and peer-to-peer transparent clock modes are not supported.
- PTP supports transport over User Datagram Protocol (UDP). Transport over Ethernet is not supported.
- PTP supports only multicast communication. Negotiated unicast communication is not supported.
- PTP is limited to a single domain per network.
- Forwarding PTP management packets is not supported.
- PTP-capable ports do not identify PTP packets and do not time-stamp or redirect those packets unless you enable PTP on those ports.
- 1 packet per second (1 pps) input is not supported.

- PTP over IPv6 is not supported.
- Inspur CN6000Series switches should be synchronized from the neighboring master using a synchronization log interval that ranges from -2 to -5.

Default Settings for PTP

The following table lists the default settings for PTP parameters.

Table 2: Default PTP Parameters

Parameters	Default
PTP	Disabled
PTP version	2
PTP domain	0
PTP priority 1 value when advertising the clock	255
PTP priority 2 value when advertising the clock	255
PTP announce interval	1 log second
PTP sync interval	- 2 log seconds
PTP announce timeout	3 announce intervals
PTP minimum delay request interval	0 log seconds
PTP VLAN	1

Configuring PTP

Configuring PTP Globally

You can enable or disable PTP globally on a device. You can also configure various PTP clock parameters to help determine which clock in the network has the highest priority to be selected as the grandmaster.

Procedure

	Command or Action	Purpose
Step 1	switch# configure terminal	Enters global configuration mode.

	Command or Action	Purpose
Step 2	switch(config) # [no] feature ptp	Enables or disables PTP on the device. Note Enabling PTP on the switch does not enable PTP on each interface.
Step 3	switch(config) # [no] ptp source ip-address [vrf vrf]	Configures the source IP address for all PTP packets. The <i>ip-address</i> can be in IPv4 format.
Step 4	switch(config) # [no] ptp domain number	(Optional) Configures the domain number to use for this clock. PTP domains allow you to use multiple independent PTP clocking subdomains on a single network. The range for the <i>number</i> is from 0 to 128.
Step 5	switch(config) # [no] ptp priority1 value	(Optional) Configures the priority1 value to use when advertising this clock. This value overrides the default criteria (clock quality, clock class, and so on) for the best master clock selection. Lower values take precedence. The range for the <i>value</i> is from 0 to 255.
Step 6	switch(config) # [no] ptp priority2 value	(Optional) Configures the priority2 value to use when advertising this clock. This value is used to decide between two devices that are otherwise equally matched in the default criteria. For example, you can use the priority2 value to give a specific switch priority over other identical switches. The range for the <i>value</i> is from 0 to 255.
Step 7	switch(config) # show ptp brief	(Optional) Displays the PTP status.
Step 8	switch(config) # show ptp clock	(Optional) Displays the properties of the local clock.
Step 9	switch(config)# copy running-config startup-config	(Optional) Saves the change persistently through reboots and restarts by copying the running configuration to the startup configuration.

The following example shows how to configure PTP globally on the device, specify the source IP address for PTP communications, and configure a preference level for the clock:

```
switch# configure terminal
switch(config)# feature ptp
switch(config)# ptp source 10.10.10.1
switch(config)# ptp priority1 1
switch(config)# ptp priority2 1
switch(config)# show ptp brief
PTP port status
-----
Port State
-----
```

```

switch(config)# show ptp clock
PTP Device Type: Boundary clock
Clock Identity : 0:22:55:ff:ff:79:a4:c1
Clock Domain: 0
Number of PTP ports: 0
Priority1 : 1
Priority2 : 1
Clock Quality:
Class : 248
Accuracy : 254
Offset (log variance) : 65535
Offset From Master : 0
Mean Path Delay : 0
Steps removed : 0
Local clock time: Mon Oct 02 14:13:24
2017 switch(config)#

```

Configuring PTP on an Interface

After you globally enable PTP, it is not enabled on all supported interfaces by default. You must enable PTP interfaces individually.

Before You Begin

Make sure that you have globally enabled PTP on the switch and configured the source IP address for PTP communication.

Procedure

	Command or Action	Purpose
Step 1	switch# configure terminal	Enters global configuration mode.
Step 2	switch(config) # interface ethernet <i>slot/port</i>	Specifies the interface on which you are enabling PTP and enters interface configuration mode.
Step 3	switch(config-if) # [no] feature ptp	Enables or disables PTP on an interface.
Step 4	switch(config-if) # [no] ptp announce {interval log seconds timeout count}	(Optional) Configures the interval between PTP announce messages on an interface or the number of PTP intervals before a timeout occurs on an interface. The range for the PTP announcement interval is from 0 to 4 seconds, and the range for the interval timeout is from 2 to 10.
Step 5	switch(config-if) # [no] ptp delay request minimum interval log <i>seconds</i>	(Optional) Configures the minimum interval allowed between PTP delay-request messages when the port is in the master state. The range is from log(-6) to log(1) seconds. Where, log(-2) = 2 frames per second.
Step 6	switch(config-if) # [no] ptp sync interval log seconds	(Optional) Configures the interval between PTP synchronization messages on an interface.

	Command or Action	Purpose
		The range for the PTP synchronization interval is from -6 log second to 1 second.
Step 7	<code>switch(config-if) # [no] ptp vlan vlan-id</code>	(Optional) Specifies the VLAN for the interface where PTP is being enabled. You can only enable PTP on one VLAN on an interface. The range is from 1 to 4094.
Step 8	<code>switch(config-if) # show ptp brief</code>	(Optional) Displays the PTP status.
Step 9	<code>switch(config-if) # show ptp port interface interface slot/port</code>	(Optional) Displays the status of the PTP port.
Step 10	<code>switch(config-if)# copy running-config startup-config</code>	(Optional) Saves the change persistently through reboots and restarts by copying the running configuration to the startup configuration.

This example shows how to configure PTP on an interface and configure the intervals for the announce, delay-request, and synchronization messages:

```
switch# configure terminal
switch(config)# interface ethernet 2/1
switch(config-if)# ptp
switch(config-if)# ptp announce interval 3
switch(config-if)# ptp announce timeout 2
switch(config-if)# ptp delay-request minimum interval 4
switch(config-if)# ptp sync interval -1
switch(config-if)# show ptp brief
PTP port status
-----
Port State
-----
Eth2/1 Master
switch(config-if)# show ptp port interface ethernet 2/1
PTP Port Dataset: Eth2/1
Port identity: clock identity: 0:22:55:ff:ff:79:a4:c1
Port identity: port number: 1028
PTP version: 2
Port state: Master
Delay request interval(log mean): 4
Announce receipt time out: 2
Peer mean path delay: 0
Announce interval(log mean): 3
Sync interval(log mean): -1
Delay Mechanism: End to End
Peer delay request interval(log mean): 0
switch(config-if)#
```

Verifying the PTP Configuration

Use one of the following commands to verify the configuration:

Table 3: PTP Show Commands

Command	Purpose
show ptp brief	Displays the PTP status.
show ptp clock	Displays the properties of the local clock, including the clock identity.
show ptp clock foreign-masters-record	Displays the state of foreign masters known to the PTP process. For each foreign master, the output displays the clock identity, basic clock properties, and whether the clock is being used as a grandmaster.
show ptp corrections	Displays the last few PTP corrections.
show ptp parent	Displays the properties of the PTP parent.
show ptp port interface ethernet <i>slot/port</i>	Displays the status of the PTP port on the switch.

CHAPTER 7

Configuring User Accounts and RBAC

This chapter contains the following sections:

- [Information About User Accounts and RBAC, page 69](#)
- [Guidelines and Limitations for User Accounts, page 75](#)
- [Configuring User Accounts, page 76](#)
- [Configuring RBAC, page 78](#)
- [Verifying the User Accounts and RBAC Configuration, page 82](#)
- [Configuring User Accounts Default Settings for the User Accounts and RBAC, page 82](#)

Information About User Accounts and RBAC

Inspur CN6000Series switches use role-based access control (RBAC) to define the amount of access that each user has when the user logs into the switch.

With RBAC, you define one or more user roles and then specify which management operations each user role is allowed to perform. When you create a user account for the switch, you associate that account with a user role, which then determines what the individual user is allowed to do on the switch.

User Roles

User roles contain rules that define the operations allowed for the user who is assigned the role. Each user role can contain multiple rules and each user can have multiple roles. For example, if role1 allows access only to configuration operations, and role2 allows access only to debug operations, users who belong to both role1 and role2 can access configuration and debug operations. You can also limit access to specific VLANs, and interfaces.

The switch provides the following default user roles:

network-admin (superuser)

Complete read and write access to the entire switch.

network-operator

Complete read access to the switch.

**Note**

If you belong to multiple roles, you can execute a combination of all the commands permitted by these roles. Access to a command takes priority over being denied access to a command. For example, suppose a user has RoleA, which denied access to the configuration commands. However, the user also has RoleB, which has access to the configuration commands. In this case, the user has access to the configuration commands.

Rules

The rule is the basic element of a role. A rule defines what operations the role allows the user to perform. You can apply rules for the following parameters:

Command

A command or group of commands defined in a regular expression.

Feature

Commands that apply to a function provided by the Inspur CN6000 device. Enter the **show role feature** command to display the feature names available for this parameter.

Feature group

Default or user-defined group of features. Enter the **show role feature-group** command to display the default feature groups available for this parameter.

These parameters create a hierarchical relationship. The most basic control parameter is the command. The next control parameter is the feature, which represents all commands associated with the feature. The last control parameter is the feature group. The feature group combines related features and allows you to easily manage the rules.

You can configure up to 256 rules for each role. The user-specified rule number determines the order in which the rules are applied. Rules are applied in descending order. For example, if a role has three rules, rule 3 is applied before rule 2, which is applied before rule 1.

User Role Policies

You can define user role policies to limit the switch resources that the user can access, or to limit access to interfaces and VLANs.

User role policies are constrained by the rules defined for the role. For example, if you define an interface policy to permit access to specific interfaces, the user does not have access to the interfaces unless you configure a command rule for the role to permit the **interface** command.

If a command rule permits access to specific resources (interfaces, VLANs), the user is permitted to access these resources, even if the user is not listed in the user role policies associated with that user.

User Account Configuration Restrictions

The following words are reserved and cannot be used to configure users:

- adm
- bin
- daemon
- ftp
- ftpuser
- games
- gdm
- gopher
- halt
- lp
- mail
- mailnull
- man
- mtsuser
- news
- nobody
- shutdown
- sync
- sys
- uucp
- xfs



Caution The Inspur CN6000 Series switches do not support all numeric usernames, even if those usernames were created in TACACS+ or RADIUS. If an all numeric username exists on an AAA server and is entered during login, the switch rejects the login request.

User Password Requirements

Inspur CN6000 device passwords are case sensitive and can contain alphanumeric characters only. Special characters, such as the dollar sign (\$) or the percent sign (%), are not allowed.

If a password is trivial (such as a short, easy-to-decipher password), the Inspur CN6000 device rejects the password. Be sure to configure a strong password for each user account. A strong password has the following characteristics:

- At least eight characters long
- Does not contain many consecutive characters (such as "abcd")
- Does not contain many repeating characters (such as "aaabbb")
- Does not contain dictionary words
- Does not contain proper names
- Contains both uppercase and lowercase characters
- Contains numbers

The following are examples of strong passwords:

- If2CoM18
- 2009AsdfLkj30
- Cb1955S21



Note For security reasons, user passwords do not display in the configuration files.

Guidelines and Limitations for User Accounts

User accounts have the following guidelines and limitations when configuring user accounts and RBAC:

- Up to 256 rules can be added to a user role.
- A maximum of 64 user roles can be assigned to a user account.
- You can assign a user role to more than one user account.
- Predefined roles such as network-admin and network-operator are not editable.



Note A user account must have at least one user role.

Configuring User Accounts



Note Changes to user account attributes do not take effect until the user logs in and creates a new session.

You can use any alphanumeric character (or) an _ (underscore) as the first character in a username. Using any other special characters for the first character is not allowed. If the username contains the characters that are not allowed, the specified user is unable to log in.

Procedure

	Command or Action	Purpose
Step 1	switch# configure terminal	Enters global configuration mode.
Step 2	switch(config)# show role	(Optional) Displays the user roles available. You can configure other user roles, if necessary.
Step 3	switch(config) # username <i>user-id</i> [password password] [expire date] [role role-name]	Configures a user account. The <i>user-id</i> is a case-sensitive, alphanumeric character string with a maximum of 28 characters. The default <i>password</i> is undefined. Note If you do not specify a password, the user might not be able to log into the switch. The expire date option format is YYYY-MM-DD. The default is no expiry date.
Step 4	switch(config) # exit	Exists global configuration mode.
Step 5	switch# show user-account	(Optional) Displays the role configuration.
Step 6	switch# copy running-config startup-config	(Optional) Copies the running configuration to the startup configuration.

The following example shows how to configure a user account:

```
switch# configure terminal
switch(config)# username NewUser password 4Ty18Rnt
switch(config)# exit
switch# show user-account
```

The following example shows the criteria in enabling the password strength-check:

```
switch(config)# username xyz password nbv12345
password is weak
Password should contain characters from at least three of the following classes: lower
case letters, upper case letters, digits and special characters.
switch(config)# username xyz password Nbv12345
password is weak
it is too simplistic/systematic
switch(config)#
```

Configuring RBAC

Creating User Roles and Rules

The rule number that you specify determines the order in which the rules are applied. Rules are applied in descending order. For example, if a role has three rules, rule 3 is applied before rule 2, which is applied before rule 1.

Procedure

	Command or Action	Purpose
Step 1	switch# configure terminal	Enters global configuration mode.
Step 2	switch(config) # role name <i>role-name</i>	Specifies a user role and enters role configuration mode. The <i>role-name</i> argument is a case-sensitive, alphanumeric character string with a maximum of 16 characters.
Step 3	switch(config-role) # rule number { deny permit } command <i>command-string</i>	Configures a command rule. The <i>command-string</i> can contain spaces and regular expressions. For example, interface ethernet * includes all Ethernet interfaces. Repeat this command for as many rules as needed.
Step 4	switch(config-role)# rule number { deny permit } { read read-write }	Configures a read-only or read-and-write rule for all operations.
Step 5	switch(config-role)# rule number { deny permit } { read read-write } feature <i>feature-name</i>	Configures a read-only or read-and-write rule for a feature. Use the show role feature command to display a list of features. Repeat this command for as many rules as needed.
Step 6	switch(config-role)# rule number { deny permit } { read read-write } feature-group <i>group-name</i>	Configures a read-only or read-and-write rule for a feature group. Use the show role feature-group command to display a list of feature groups. Repeat this command for as many rules as needed.

	Command or Action	Purpose
Step 7	switch(config-role)# description <i>text</i>	(Optional) Configures the role description. You can include spaces in the description.
Step 8	switch(config-role)# end	Exits role configuration mode.
Step 9	switch# show role	(Optional) Displays the user role configuration.
Step 10	switch# copy running-config startup-config	(Optional) Saves the change persistently through reboots and restarts by copying the running configuration to the startup configuration.

This example shows how to create user roles and specify rules:

```
switch# configure terminal
switch(config)# role name UserA
switch(config-role)# rule deny command clear users
switch(config-role)# rule deny read-write
switch(config-role)# description This role does not allow users to use clear commands
switch(config-role)# end
switch(config)# show role
```

Creating Feature Groups

Procedure

	Command or Action	Purpose
Step 1	switch# configure terminal	Enters global configuration mode.
Step 2	switch(config) # role feature-group <i>group-name</i>	Specifies a user role feature group and enters role feature group configuration mode. The <i>group-name</i> is a case-sensitive, alphanumeric character string with a maximum of 32 characters.
Step 3	switch(config) # exit	Exits global configuration mode.
Step 4	switch# show role feature-group	(Optional) Displays the role feature group configuration.
Step 5	switch# copy running-config startup-config	(Optional) Saves the change persistently through reboots and restarts by copying the running configuration to the startup configuration.

This example shows how to create a feature group:

```
switch# configure terminal
switch(config) # role feature-group group1
switch(config) # exit
switch# show role feature-group
switch# copy running-config startup-config
switch#
```

Changing User Role Interface Policies

You can change a user role interface policy to limit the interfaces that the user can access. Specify a list of interfaces that the role can access. You can specify it for as many interfaces as needed.

Procedure

	Command or Action	Purpose
Step 1	switch# configure terminal	Enters global configuration mode.
Step 2	switch(config) # role name <i>role-name</i>	Specifies a user role and enters role configuration mode.
Step 3	switch(config-role) # interface policy deny	Enters role interface policy configuration mode.
Step 4	switch(config-role-interface) # permit interface <i>interface-list</i>	Specifies a list of interfaces that the role can access. Repeat this command for as many interfaces as needed. For this command, you can specify Ethernet interfaces.
Step 5	switch(config-role-interface) # exit	Exits role interface policy configuration mode.
Step 6	switch(config-role) # show role	(Optional) Displays the role configuration.
Step 7	switch(config-role) # copy running-config startup-config	(Optional) Copies the running configuration to the startup configuration.

The following example shows how to change a user role interface policy to limit the interfaces that the user can access:

```
switch# configure terminal
switch(config)# role name UserB
switch(config-role)# interface policy deny
switch(config-role-interface)# permit interface ethernet 2/1
switch(config-role-interface)# permit interface fc 3/1
switch(config-role-interface)# permit interface vfc 30/1
```

Changing User Role VLAN Policies

You can change a user role VLAN policy to limit the VLANs that the user can access.

Procedure

	Command or Action	Purpose
Step 1	switch# configure terminal	Enters global configuration mode.
Step 2	switch(config) # role name <i>role-name</i>	Specifies a user role and enters role configuration mode.
Step 3	switch(config-role) # vlan policy deny	Enters role VLAN policy configuration mode.
Step 4	switch(config-role-vlan) # permit vlan <i>vlan-list</i>	Specifies a range of VLANs that the role can access. Repeat this command for as many VLANs as needed.
Step 5	switch(config-role-vlan) # exit	Exits role VLAN policy configuration mode.
Step 6	switch# show role	(Optional) Displays the role configuration.
Step 7	switch# copy running-config startup-config	(Optional) Saves the change persistently through reboots and restarts by copying the running configuration to the startup configuration.

	Command or Action	Purpose
Step 6	switch# show role	(Optional) Displays the role configuration.
Step 7	switch# copy running-config startup-config	(Optional) Saves the change persistently through reboots and restarts by copying the running configuration to the startup configuration.

Verifying the User Accounts and RBAC Configuration

Use one of the following commands to verify the configuration:

Command	Purpose
show role [<i>role-name</i>]	Displays the user role configuration
show role feature	Displays the feature list.
show role feature-group	Displays the feature group configuration.
show startup-config security	Displays the user account configuration in the startup configuration.
show running-config security [all]	Displays the user account configuration in the running configuration. The all keyword displays the default values for the user accounts.
show user-account	Displays user account information.

Configuring User Accounts Default Settings for the User Accounts and RBAC

The following table lists the default settings for user accounts and RBAC parameters.

Table 5: Default User Accounts and RBAC Parameters

Parameters	Default
User account password	Undefined.
User account expiry date	None.

Parameters	Default
Interface policy	All interfaces are accessible.
VLAN policy	All VLANs are accessible.
VFC policy	All VFCs are accessible.
VETH policy	All VETHs are accessible.

Configuring Session Manager

This chapter contains the following sections:

- [Information About Session Manager, page 85](#)
- [Guidelines and Limitations for Session Manager, page 85](#)
- [Configuring Session Manager, page 86](#)
- [Verifying the Session Manager Configuration, page 88](#)

Information About Session Manager

Session Manager allows you to implement your configuration changes in batch mode. Session Manager works in the following phases:

- **Configuration session**—Creates a list of commands that you want to implement in session manager mode.
- **Validation**—Provides a basic semantic check on your configuration. Inspur INOS-CN returns an error if the semantic check fails on any part of the configuration.
- **Verification**—Verifies the configuration as a whole, based on the existing hardware and software configuration and resources. Inspur INOS-CN returns an error if the configuration does not pass this verification phase.
- **Commit**— Inspur INOS-CN verifies the complete configuration and implements the changes atomically to the device. If a failure occurs, Inspur INOS-CN reverts to the original configuration.
- **Abort**—Discards the configuration changes before implementation.

You can optionally end a configuration session without committing the changes. You can also save a configuration session.

Guidelines and Limitations for Session Manager

Session Manager has the following configuration guidelines and limitations:

- Session Manager supports only the access control list (ACL) feature.
- You can create up to 32 configuration sessions.
- You can configure a maximum of 20,000 commands across all sessions.

Configuring Session Manager

Creating a Session

You can create up to 32 configuration sessions.

Procedure

	Command or Action	Purpose
Step 1	switch# configure session <i>name</i>	Creates a configuration session and enters session configuration mode. The name can be any alphanumeric string. Displays the contents of the session.
Step 2	switch(config-s)# show configuration session [<i>name</i>]	(Optional) Displays the contents of the session.
Step 3	switch(config-s)# save <i>location</i>	(Optional) Saves the session to a file. The location can be in bootflash or volatile.

Configuring ACLs in a Session

You can configure ACLs within a configuration session.

Procedure

	Command or Action	Purpose
Step 1	switch# configure session <i>name</i>	Creates a configuration session and enters session configuration mode. The name can be any alphanumeric string.
Step 2	switch(config-s)# ip access-list <i>name</i>	Creates an ACL.
Step 3	switch(config-s-acl)# permit <i>protocol source destination</i>	(Optional) Adds a permit statement to the ACL.

	Command or Action	Purpose
Step 4	switch(config-s-acl)# interface <i>interface-type</i> <i>number</i>	Enters interface configuration mode.
Step 5	switch(config-s-if)# ip port access-group <i>name in</i>	Adds a port access group to the interface.
Step 6	switch# show configuration session [<i>name</i>]	(Optional) Displays the contents of the session.

Verifying a Session

To verify a session, use the following command in session mode:

Command	Purpose
switch(config-s)# verify [verbose]	Verifies the commands in the configuration session.

Committing a Session

To commit a session, use the following command in session mode:

Command	Purpose
switch(config-s)# commit [verbose]	Commits the commands in the configuration session.

Saving a Session

To save a session, use the following command in session mode:

Command	Purpose
switch(config-s)# save <i>location</i>	(Optional) Saves the session to a file. The location can be in bootflash or volatile.

Discarding a Session

To discard a session, use the following command in session mode:

Command	Purpose
switch(config-s)# abort	Discards the configuration session without applying the commands.

Configuration Example for Session Manager

The following example shows how to create a configuration session for ACLs:

```
switch# configure session name test2
switch(config-s) # ip access-list acl2
switch(config-s-acl) # permit tcp any any
switch(config-s-acl) # exit
switch(config-s) # interface Ethernet 1/4
switch(config-s-ip) # ip port access-group acl2 in
switch(config-s-ip) # exit
switch(config-s) # verify
switch(config-s) # exit
switch# show configuration session test2
```

Verifying the Session Manager Configuration

To verify Session Manager configuration information, perform one of the following tasks:

Command	Purpose
show configuration session [<i>name</i>]	Displays the contents of the configuration session.
show configuration session status [<i>name</i>]	Displays the status of the configuration session.
show configuration session summary	Displays a summary of all the configuration sessions.

Configuring the Scheduler

This chapter contains the following sections:

- [Information About the Scheduler, page 89](#)
- [Licensing Requirements for the Scheduler, page 90](#)
- [Guidelines and Limitations for the Scheduler, page 90](#)
- [Default Settings for the Scheduler, page 91](#)
- [Configuring the Scheduler, page 91](#)
- [Verifying the Scheduler Configuration, page 97](#)
- [Configuration Examples for the Scheduler, page 97](#)
- [Standards for the Scheduler, page 99](#)

Information About the Scheduler

The scheduler allows you to define and set a timetable for maintenance activities such as the following:

- Quality of service policy changes
- Data backup
- Saving a configuration

Jobs consist of a single command or multiple commands that define routine activities. Jobs can be scheduled one time or at periodic intervals.

The scheduler defines a job and its timetable as follows:

Job

A routine task or tasks defined as a command list and completed according to a specified schedule.

Schedule

The timetable for completing a job. You can assign multiple jobs to a schedule.

A schedule is defined as either periodic or one-time only:

- Periodic mode— A recurring interval that continues until you delete the job. You can configure the following types of intervals:
 - Daily— Job is completed once a day.
 - Weekly— Job is completed once a week.
 - Monthly—Job is completed once a month.
 - Delta—Job begins at the specified start time and then at specified intervals (days:hours:minutes).
- One-time mode—Job is completed only once at a specified time.

Remote User Authentication

Before starting a job, the scheduler authenticates the user who created the job. Because user credentials from a remote authentication are not retained long enough to support a scheduled job, you must locally configure the authentication passwords for users who create jobs. These passwords are part of the scheduler configuration and are not considered a locally configured user.

Before starting the job, the scheduler validates the local password against the password from the remote authentication server.

Scheduler Log Files

The scheduler maintains a log file that contains the job output. If the size of the job output is greater than the size of the log file, the output is truncated.

Licensing Requirements for the Scheduler

This feature does not require a license. Any feature not included in a license package is bundled with the Inspur INOS-CN image and is provided at no extra charge to you.

Guidelines and Limitations for the Scheduler

- The scheduler can fail if it encounters one of the following while performing a job:
 - If a feature license is expired when a job for that feature is scheduled.
 - If a feature is disabled at the time when a job for that feature is scheduled.

- Verify that you have configured the time. The scheduler does not apply a default timetable. If you create a schedule, assign jobs, and do not configure the time, the job is not started.
- While defining a job, verify that no interactive or disruptive commands (for example, **copy bootflash: file ftp:URI, write erase**, and other similar commands) are specified because the job is started and conducted noninteractively.

Default Settings for the Scheduler

Table 6: Default Command Scheduler Parameters

Parameters	Default
Scheduler state	Disabled
Log file size	16 KB

Configuring the Scheduler

Enabling the Scheduler

Procedure

	Command or Action	Purpose
Step 1	switch# configure terminal	Enters global configuration mode.
Step 2	switch(config) # feature scheduler	Enables the scheduler.
Step 3	switch(config) # show scheduler config	(Optional) Displays the scheduler configuration.
Step 4	switch(config)# copy running-config startup-config	(Optional) Saves the change persistently through reboots and restarts by copying the running configuration to the startup configuration.

This example shows how to enable the scheduler:

```
switch# configure terminal
switch(config)# feature scheduler
switch(config)# show scheduler config
config terminal
    feature scheduler
    scheduler logfile size 16
end
switch(config)#
```

Defining the Scheduler Log File Size

Procedure

	Command or Action	Purpose
Step 1	switch# configure terminal	Enters global configuration mode.
Step 2	switch(config) # scheduler logfile size value	Defines the scheduler log file size in kilobytes. The range is from 16 to 1024. The default log file size is 16. Note If the size of the job output is greater than the size of the log file, the output is truncated.
Step 3	switch(config)# copy running-config startup-config	(Optional) Saves the change persistently through reboots and restarts by copying the running configuration to the startup configuration.

This example shows how to define the scheduler log file size:

```
switch# configure terminal
switch(config) # scheduler logfile size 1024
switch(config) #
```

Configuring Remote User Authentication

Remote users must authenticate with their clear text password before creating and configuring jobs.

Remote user passwords are always shown in encrypted form in the output of the **show running-config** command. The encrypted option (**7**) in the command supports the ASCII device configuration.

Procedure

	Command or Action	Purpose
Step 1	switch# configure terminal	Enters global configuration mode.
Step 2	switch(config) # scheduler aaa-authentication password [0 7] password	Configures a password for the user who is currently logged in. To configure a clear text password, enter 0 . To configure an encrypted password, enter 7 .
Step 3	switch(config) # scheduler aaa-authentication username name password [0 7] password	Configures a clear text password for a remote user.

	Command or Action	Purpose
Step 4	switch(config) # show running-config include "scheduler aaa-authentication"	(Optional) Displays the scheduler password information.
Step 5	switch(config)# copy running-config startup-config	(Optional) Saves the change persistently through reboots and restarts by copying the running configuration to the startup configuration.

This example shows how to configure a clear text password for a remote user called NewUser:

```
switch# configure terminal
switch(config) # scheduler aaa-authentication username NewUser password z98y76x54b
switch(config) # copy running-config startup-config
switch(config) #
```

Defining a Job

Once a job is defined, you cannot modify or remove a command. To change the job, you must delete it and create a new one.

Procedure

	Command or Action	Purpose
Step 1	switch# configure terminal	Enters global configuration mode.
Step 2	switch(config) # scheduler job name name	Creates a job with the specified name and enters job configuration mode. The <i>name</i> is restricted to 31 characters.
Step 3	switch(config-job) # command1 ; [command2 ;command3 ; ...	Defines the sequence of commands for the specified job. You must separate commands with a space and a semicolon (;). The filename is created using the current time stamp and switch name.
Step 4	switch(config-job) # show scheduler job [name]	(Optional) Displays the job information. The <i>name</i> is restricted to 31 characters.
Step 5	switch(config-job) # copy running-config startup-config	(Optional) Saves the change persistently through reboots and restarts by copying the running configuration to the startup configuration.

This example shows how to create a scheduler job named backup-cfg, save the running configuration to a file in bootflash, copy the file from bootflash to a TFTP server, and save the change to the startup configuration:

```
switch# configure terminal
switch(config) # scheduler job name backup-cfg
switch(config-job) # cli var name timestamp
$(timestamp) ;copy running-config
bootflash:/${SWITCHNAME}-cfg.$(timestamp) ;copy
bootflash:/${SWITCHNAME}-cfg.$(timestamp)
tftp://1.2.3.4/ vrf management
switch(config-job) # copy running-config startup-config
```

Deleting a Job

Procedure

	Command or Action	Purpose
Step 1	switch# configure terminal	Enters global configuration mode.
Step 2	switch(config) # no scheduler job name <i>name</i>	Deletes the specified job and all commands defined within it. The <i>name</i> is restricted to 31 characters.
Step 3	switch(config-job) # show scheduler job <i>[name]</i>	(Optional) Displays the job information.
Step 4	switch(config-job) # copy running-config startup-config	(Optional) Saves the change persistently through reboots and restarts by copying the running configuration to the startup configuration.

This example shows how to delete a job called configsave:

```
switch# configure terminal
switch(config) # no scheduler job name configsave
switch(config-job) # copy running-config startup-config
switch(config-job) #
```

Defining a Timetable

You must configure a timetable. Otherwise, jobs will not be scheduled.

If you do not specify the time for the **time** commands, the scheduler assumes the current time. For example, if the current time is October 2, 2017, 22:00 hours, jobs are started as follows:

- For the **time start 23:00 repeat 4:00:00** command, the scheduler assumes a start time of October 2, 2017, 23:00 hours.
- For the **time daily 55** command, the scheduler assumes a start time every day at 22:55 hours.
- For the **time weekly 23:00** command, the scheduler assumes a start time every Friday at 23:00 hours.

- For the **time monthly 23:00** command, the scheduler assumes a start time on the 2nd of every month at 23:00 hours.



Note The scheduler will not begin the next occurrence of a job before the last one completes. For example, you have scheduled a job to be completed at one-minute intervals beginning at 22:00; but the job requires two minutes to complete. The scheduler starts the first job at 22:00, completes it at 22:02, and then observes a one-minute interval before starting the next job at 22:03.

Procedure

	Command or Action	Purpose
Step 1	switch# configure terminal	Enters global configuration mode.
Step 2	switch(config) # scheduler schedule name name	Creates a new scheduler and enters schedule configuration mode for that schedule. The <i>name</i> is restricted to 31 characters.
Step 3	switch(config-schedule) # job name name	Associates a job with this schedule. You can add multiple jobs to a schedule. The <i>name</i> is restricted to 31 characters.
Step 4	switch(config-schedule) # time daily time	Indicates the job starts every day at a designated time, specified as HH:MM.
Step 5	switch(config-schedule) # time weekly [[day-of-week:] HH:] MM	Indicates that the job starts on a specified day of the week. The day of the week is represented by an integer (for example, 1 for Sunday, 2 for Monday) or as an abbreviation (for example, sun , mon). The maximum length for the entire argument is 10 characters.
Step 6	switch(config-schedule) # time monthly [[day-of-month:] HH:] MM	Indicates that the job starts on a specified day each month. If you specify 29, 30, or 31, the job is started on the last day of each month.
Step 7	switch(config-schedule) # time start {now repeat repeat-interval delta-time [repeat repeat-interval]}	Indicates the job starts periodically. The start-time format is [[[yyyy:]mmm:]dd:]HH]:MM. <ul style="list-style-type: none"> • <i>delta-time</i>— Specifies the amount of time to wait after the schedule is configured before starting a job. • now— Specifies that the job starts two minutes from now. • repeat repeat-interval— Specifies the frequency at which the job is repeated.

	Command or Action	Purpose
Step 8	switch(config-schedule) # show scheduler config	(Optional) Displays the scheduler information.
Step 9	switch(config-schedule) # copy running-config startup-config	(Optional) Saves the change persistently through reboots and restarts by copying the running configuration to the startup configuration.

This example shows how to define a timetable where jobs start on the 28th of each month at 23:00 hours:

```
switch# configure terminal
switch(config)# scheduler schedule name weekendbackupqos
switch(config-scheduler)# job name offpeakzoning
switch(config-scheduler)# time monthly 28:23:00
switch(config-scheduler)# copy running-config startup-config
switch(config-scheduler)#
```

Clearing the Scheduler Log File

Procedure

	Command or Action	Purpose
Step 1	switch# configure terminal	Enters global configuration mode.
Step 2	switch(config) # clear scheduler logfile	Clears the scheduler log file.

This example shows how to clear the scheduler log file:

```
switch# configure terminal
switch(config)# clear scheduler logfile
```

Disabling the Scheduler

Procedure

	Command or Action	Purpose
Step 1	switch# configure terminal	Enters global configuration mode.
Step 2	switch(config) # no feature scheduler	Disables the scheduler.
Step 3	switch(config) # show scheduler config	(Optional) Displays the scheduler configuration.

	Command or Action	Purpose
Step 4	switch(config)# copy running-config startup-config	(Optional) Saves the change persistently through reboots and restarts by copying the running configuration to the startup configuration.

This example shows how to disable the scheduler:

```
switch# configure terminal
switch(config) # no feature scheduler
switch(config) # copy running-config startup-config
switch(config) #
```

Verifying the Scheduler Configuration

Use one of the following commands to verify the configuration:

Table 7: Scheduler Show Commands

Command	Purpose
show scheduler config	Displays the scheduler configuration.
show scheduler job [name name]	Displays the jobs configured.
show scheduler logfile	Displays the contents of the scheduler log file.
show scheduler schedule [name name]	Displays the schedules configured.

Configuration Examples for the Scheduler

Creating a Scheduler Job

This example shows how to create a scheduler job that saves the running configuration to a file in bootflash and then copies the file from bootflash to a TFTP server (the filename is created using the current time stamp and switch name):

```
switch# configure terminal
switch(config)# scheduler job name backup-cfg
switch(config-job)# cli var name timestamp $(TIMESTAMP) ;copy running-config
bootflash:/${SWITCHNAME}-cfg,${timestamp} ;copy bootflash:/${SWITCHNAME}-
cfg,${timestamp} tftp://1.2.3.4/ vrf management
switch(config-job)# end
switch(config)#
```

Scheduling a Scheduler Job

This example shows how to schedule a scheduler job called backup-cfg to run daily at 1 a.m.:

```
switch# configure terminal
switch(config)# scheduler schedule name daily
switch(config-schedule)# job name backup-cfg
switch(config-schedule)# time daily 1:00
switch(config-schedule)# end
switch(config)#
```

Displaying the Job Schedule

This example shows how to display the job schedule:

```
switch# show scheduler schedule
Schedule Name      : daily
-----
User Name          : admin
Schedule Type      : Run every day at 1 Hrs 00 Mins
Last Execution Time : Mon Oct 2 1:00:00 2017
Last Completion Time: Mon Oct 2 1:00:01 2017
Execution count    : 2
-----
Job Name           Last Execution Status
-----
back-cfg           Success (0)
switch(config)#
```

Displaying the Results of Running Scheduler Jobs

This example shows how to display the results of scheduler jobs that have been executed by the scheduler:

```
switch# show scheduler logfile
Job Name           : back-cfg           Job Status: Failed (1)
Schedule Name      : daily             User Name : admin
Completion time: Mon Oct 2  1:00:01 2017
-----
-----
Job Output -----
`cli var name timestamp 2017-01-01-01.00.00`
`copy running-config bootflash:/${(HOSTNAME)}-cfg.${(timestamp)} `
`copy bootflash:/switch-cfg.2017-10-02-01.00.00 tftp://1.2.3.4/ vrf management `
copy: cannot access file '/bootflash/switch-cfg.2017-10-02-01.00.00'
=====
Job Name           : back-cfg           Job Status: Success (0)
Schedule Name      : daily             User Name : admin
Completion time: Mon Oct 2  1:00:01 2017
-----
-----
Job Output -----
`cli var name timestamp 2017-10-02-01.00.00`
`copy running-config bootflash:/switch-cfg. 2017-10-02-01.00.00`
`copy bootflash:/switch-cfg.2017-10-02-01.00.00 tftp://1.2.3.4/ vrf management
Connection to Server Established.
[           ]          0.50KBTrying to connect to tftp server.....
[#####    ]          24.50KB
TFTP put operation was successful
=====
switch#
```

CHAPTER 10

Configuring Online Diagnostics

This chapter contains the following sections:

- [Information About Online Diagnostics, page 101](#)
- [Guidelines and Limitations for Online Diagnostics, page 104](#)
- [Configuring Online Diagnostics, page 104](#)
- [Verifying the Online Diagnostics Configuration, page 105](#)
- [Default Settings for Online Diagnostics, page 105](#)
- [Parity Error Diagnostics, page 106](#)

Information About Online Diagnostics

Online diagnostics provide verification of hardware components during switch bootup or reset, and they monitor the health of the hardware during normal switch operation.

Inspur CN6000Series switches support bootup diagnostics and runtime diagnostics. Bootup diagnostics include disruptive tests and nondisruptive tests that run during system bootup and system reset.

Runtime diagnostics (also known as health monitoring diagnostics) include nondisruptive tests that run in the background during normal operation of the switch.

Bootup Diagnostics

Bootup diagnostics detect faulty hardware before bringing the switch online. Bootup diagnostics also check the data path and control path connectivity between the supervisor and the ASICs. The following table describes the diagnostics that are run only during switch bootup or reset.

Table 8: Bootup Diagnostics

Diagnostic	Description
PCIe	Tests PCI express (PCIe) access.

Diagnostic	Description
NVRAM	Verifies the integrity of the NVRAM.
In band port	Tests connectivity of the inband port to the supervisor.
Management port	Tests the management port.
Memory	Verifies the integrity of the DRAM.

Bootup diagnostics also include a set of tests that are common with health monitoring diagnostics.

Bootup diagnostics log any failures to the onboard failure logging (OBFL) system. Failures also trigger an LED display to indicate diagnostic test states (on, off, pass, or fail).

You can configure Inspur CN6000 device to either bypass the bootup diagnostics or run the complete set of bootup diagnostics.

Health Monitoring Diagnostics

Health monitoring diagnostics provide information about the health of the switch. They detect runtime hardware errors, memory errors, software faults, and resource exhaustion.

Health monitoring diagnostics are nondisruptive and run in the background to ensure the health of a switch that is processing live network traffic.

The following table describes the health monitoring diagnostics for the switch.

Table 9: Health Monitoring Diagnostics Tests

Diagnostic	Description
LED	Monitors port and system status LEDs.
Power Supply	Monitors the power supply health state.
Temperature Sensor	Monitors temperature sensor readings.
Test Fan	Monitors the fan speed and fan control.



Note

When the switch reaches the intake temperature threshold and does not go within the limits in 120 seconds, the switch will power off and the power supplies will have to be re-seated to recover the switch

The following table describes the health monitoring diagnostics that also run during system boot or system reset.

Table 10: Health Monitoring and Bootup Diagnostics Tests

Diagnostic	Description
SPROM	Verifies the integrity of backplane and supervisor SPROMs.
Fabric engine	Tests the switch fabric ASICs.
Fabric port	Tests the ports on the switch fabric ASIC.
Forwarding engine	Tests the forwarding engine ASICs.
Forwarding engine port	Tests the ports on the forwarding engine ASICs.
Front port	Tests the components (such as PHY and MAC) on the front ports.

**Note**

When the switch exceeds the internal temperature threshold of 70 degrees Celsius and does not decrease below the threshold limit within 120 seconds, the switch powers off and the switch must be properly power-cycled in order to recover the switch.

Expansion Module Diagnostics

During the switch bootup or reset, the bootup diagnostics include tests for the in-service expansion modules in the switch.

When you insert an expansion module into a running switch, a set of diagnostics tests are run. The following table describes the bootup diagnostics for an expansion module. These tests are common with the bootup diagnostics. If the bootup diagnostics fail, the expansion module is not placed into service.

Table 11: Expansion Module Bootup and Health Monitoring Diagnostics

Diagnostic	Description
SPROM	Verifies the integrity of backplane and supervisor SPROMs.
Fabric engine	Tests the switch fabric ASICs.
Fabric port	Tests the ports on the switch fabric ASIC.
Forwarding engine	Tests the forwarding engine ASICs.
Forwarding engine port	Tests the ports on the forwarding engine ASICs.

Diagnostic	Description
Front port	Tests the components (such as PHY and MAC) on the front ports.

Health monitoring diagnostics are run on in-service expansion modules. The following table describes the additional tests that are specific to health monitoring diagnostics for expansion modules.

Table 12: Expansion Module Health Monitoring Diagnostics

Diagnostic	Description
LED	Monitors port and system status LEDs.
Temperature Sensor	Monitors temperature sensor readings.

Guidelines and Limitations for Online Diagnostics

Online diagnostics has the following configuration guidelines and limitations:

- You cannot run disruptive online diagnostic tests on demand.
- The BootupPortLoopback test is not supported.
- Interface Rx and Tx packet counters are incremented (approximately four packets every 15 minutes) for ports in the shutdown state.
- On admin down ports, the unicast packet Rx and Tx counters are incremented for GOLD loopback packets. The PortLoopback test is periodic, so the packet counter is incremented on admin down ports every 30 minutes. The test runs only on admin down ports. When a port is unshut, the counters are not affected.

Configuring Online Diagnostics

You can configure the bootup diagnostics to run the complete set of tests, or you can bypass all bootup diagnostic tests for a faster module boot up time.



Note

We recommend that you set the bootup online diagnostics level to complete. We do not recommend bypassing the bootup online diagnostics.

Procedure

	Command or Action	Purpose
Step 1	switch# configure terminal	Enters global configuration mode.
Step 2	switch(config)# diagnostic bootup level [complete bypass]	Configures the bootup diagnostic level to trigger diagnostics when the device boots, as follows: <ul style="list-style-type: none"> • complete—Performs all bootup diagnostics. This is the default value. • bypass—Does not perform any bootup diagnostics.
Step 3	switch# show diagnostic bootup level	(Optional) Displays the bootup diagnostic level (bypass or complete) that is currently in place on the switch.

The following example shows how to configure the bootup diagnostics level to trigger the complete diagnostics:

```
switch# configure terminal
switch(config)# diagnostic bootup level complete
```

Verifying the Online Diagnostics Configuration

Use the following commands to verify online diagnostics configuration information:

Command	Purpose
show diagnostic bootup level	Displays the bootup diagnostics level.
show diagnostic result module slot	Displays the results of the diagnostics tests.

Default Settings for Online Diagnostics

The following table lists the default settings for online diagnostics parameters.

Table 13: Default Online Diagnostics Parameters

Parameters	Default
Bootup diagnostics level	complete

Parity Error Diagnostics

Clearing Parity Errors

The following guidelines apply:

- When the command is used for an l2_entry table, the cleared entry should be relearned due to the traffic pattern.
- When the command is used for an l3_entry_only (host) table, the cleared entry is not be relearned.

The command is useful in the following customer configurations:

- L2_Entry table, with no static L2_entry table entries
If the L2_Entry table entry is cleared, the entry should be dynamically learned through the traffic pattern. It should not be learned through IGMP or multicast.
- L3_Entry_only (host) table
Customers should not use the host table. The **hardware profile unicast enable-host-ecmp** command should be enabled. In this case, the customer node does not have any valid entries in the L3_Entry_only table, so clearing the L3_Entry_only entry table should not have any impact.

Procedure

	Command or Action	Purpose
Step 1	switch# configure terminal	Enters global configuration mode.
Step 2	switch(config)# hardware profile parity-error l2-table clear	Clears parity error entries in a Layer 2 table.
Step 3	switch(config)# hardware profile parity-error l3-table clear	Clears parity error entries in a Layer 3 table.

This example shows how to clear parity errors in a Layer 2 table:

```
switch# configure terminal
switch(config)# hardware profile parity-error l2-table clear
switch(config)# copy running-config startup-config
switch(config)# reload
```

This example shows how to clear parity errors in a Layer 3 table:

```
switch# configure terminal
switch(config)# hardware profile parity-error l3-table clear
switch(config)# copy running-config startup-config
switch(config)# reload
```

Soft Error Recovery

Software Error Recovery (SER) for soft errors is in the internal memory tables of the forwarding engine. This feature is enabled by default.

The forwarding engine internal control tables and packet memories are protected through various mechanisms such as error-correcting code (ECC), parity protection, or software scan based parity check of the tables. Software caches are maintained for most of the hardware tables. Parity and ECC errors are detected when the traffic hits the affected entries. For ternary content addressable memories (TCAMs), an error is detected when the CPU compares the software shadow entries to the hardware entries. When any of these types of errors are detected, an interrupt is generated to report an error for that memory.

The correction mechanism is different for different hardware tables. For hardware tables that have a software shadow, the affected entry is copied from the software cache and the interrupt is cleared. Hardware tables, such as the Layer 3 host lookup table and the ACL TCAM tables, are detected and corrected in this way. For hardware tables that do not have a software shadow, the affected entry is cleared or zeroed out. Hardware tables, such as the hardware-learned Layer 2 entry table, and the counters' memory are detected and corrected in this way.

When a parity error is encountered in the hardware in the forwarding lookup for the packet, the packet is subject to a drop depending on the table encountering the parity error. The recovery time from the parity error detection to correction, in this case, for an entry can be over 600 microseconds. If the traffic is hitting this entry, there will be traffic loss for this duration.

For TCAM tables that do not have parity protection, a periodic software scan is done for the table entries to detect parity errors. In case of parity error detection, the system copies the affected memory location from the software shadow to correct the error. Software initiated scan is done every 10 seconds with 4,000 entries scanned per interval. There are about 36,000 TCAM entries to be scanned in the forwarding engine. In the worst case scenario, it can take over 90 seconds for parity error detection and correction for these tables, the recovery time is based on the system load.

In case of unrecoverable parity errors, the software generates a syslog event notification as shown in the following example:

```
2017 Oct 2 12:37:32 switch %USER-3-SYSTEM_MSG: bcm_usd_isr_switch_event_cb_log:658:
 slot_num 0, event 2, memory error type: Detection(0x1), table name: Ingress ACL result
 table(0x830004b5), index: 1790 - bcm_usd
```

Verifying Memory Table Health

To display a summary of parity error counts encountered in ASIC memory tables, run the following command:

Command	Purpose
show hardware forwarding memory health summary	Displays a summary of parity error counts in ASIC memory tables.

The following example shows how to display a summary of parity error counts in ASIC memory tables:

```
switch# show hardware forwarding memory health summary
Parity error counters:
Total parity error detections: 7
Total parity error corrections: 7
Total TCAM table parity error detections: 1
Total TCAM table parity error corrections: 1
Total SRAM table parity error detections: 6
Total SRAM table parity error corrections: 6
Parity error summary:
Table ID: L2 table      Detections: 1   Corrections: 1
Table ID: L3 Host table Detections: 1   Corrections: 1
Table ID: L3 LPM table  Detections: 1   Corrections: 1
Table ID: L3 LPM result table Detections: 1   Corrections: 1
Table ID: Ingress pre-lookup ACL result table Detections: 1   Corrections: 1
Table ID: Ingress ACL result table      Detections: 1   Corrections: 1
Table ID: Egress ACL result table        Detections: 1   Corrections: 1
```

CHAPTER 11

Configuring the Embedded Event Manager

This chapter contains the following sections:

- [Information About Embedded Event Manager, page 109](#)
- [Configuring Embedded Event Manager, page 113](#)
- [Verifying the Embedded Event Manager Configuration, page 123](#)
- [Configuration Examples for Embedded Event Manager, page 124](#)
- [Additional References, page 124](#)
- [Feature History for EEM, page 125](#)

Information About Embedded Event Manager

The ability to detect and handle critical events in the Inspur INOS-CN system is important for high availability. The Embedded Event Manager (EEM) provides a central, policy-driven framework to detect and handle events in the system by monitoring events that occur on your device and taking action to recover or troubleshoot these events, based on your configuration.

EEM consists of three major components:

Event statements

Events to monitor from another Inspur INOS-CN component that may require some action, workaround, or notification.

Action statements

An action that EEM can take, such as sending an e-mail or disabling an interface, to recover from an event.

Policies

An event paired with one or more actions to troubleshoot or recover from the event.

Without EEM, each individual component is responsible for detecting and handling its own events. For example, if a port flaps frequently, the policy of "putting it into errDisable state" is built into ETHPM.

Embedded Event Manager Policies

An EEM policy consists of an event statement and one or more action statements. The event statement defines the event to look for as well as the filtering characteristics for the event. The action statement defines the action EEM takes when the event occurs.

For example, you can configure an EEM policy to identify when a card is removed from the device and log the details related to the card removal. By setting up an event statement that tells the system to look for all instances of card removal and then with an action statement that tells the system to log the details.

You can configure EEM policies using the command line interface (CLI) or a VSH script.

EEM gives you a device-wide view of policy management. Once EEM policies are configured, the corresponding actions are triggered. All actions (system or user-configured) for triggered events are tracked and maintained by the system.

Preconfigured System Policies

Inspur INOS-CN has a number of preconfigured system policies. These system policies define many common events and actions for the device. System policy names begin with two underscore characters (__).

Some system policies can be overridden. In these cases, you can configure overrides for either the event or the action. The overrides that you configure take the place of the system policy.



Note

Override policies must include an event statement. Override policies without event statements override all possible events for the system policy.

To view the preconfigured system policies and determine which policies you can override, use the **show event manager system-policy** command.

User-Created Policies

User-created policies allow you to customize EEM policies for your network. If a user policy is created for an event, actions in the policy are triggered only after EEM triggers the system policy actions related to the same event.

Log Files

The log file that contains data that is related to EEM policy matches is maintained in the event_archive_1 log file located in the /log/event_archive_1 directory.

Event Statements

Any device activity for which some action, such as a workaround or notification, is taken is considered an event by EEM. In many cases, events are related to faults in the device, such as when an interface or a fan malfunction.

Event statements specify which event or events triggers a policy to run.

**Tip**

You can configure EEM to trigger an EEM policy that is based on a combination of events by creating and differentiating multiple EEM events in the policy and then defining a combination of events to trigger a custom action.

EEM defines event filters so that only critical events or multiple occurrences of an event within a specified time period trigger an associated action.

Some commands or internal events trigger other commands internally. These commands are not visible, but will still match the event specification that triggers an action. You cannot prevent these commands from triggering an action, but you can check which event triggered an action.

Supported Events

EEM supports the following events in event statements:

- Counter events
- Fan absent events
- Fan bad events
- Memory thresholds events
- Events being used in overridden system policies.
- SNMP notification events
- Syslog events
- System manager events
- Temperature events
- Track events

Action Statements

Action statements describe the action that is triggered by a policy when an event occurs. Each policy can have multiple action statements. If no action is associated with a policy, EEM still observes events but takes no actions.

In order for triggered events to process default actions, you must configure the EEM policy to allow the default action. For example, if you match a CLI command in a match statement, you must add the event-default action statement to the EEM policy or EEM does not allow the command to execute.

**Note**

When configuring action statements within your user policy or overriding policy, it is important that you confirm that action statements do not negate each other or adversely affect the associated system policy.

Supported Actions

EEM supports the following actions in action statements:

- Execute any CLI commands

- Update a counter
- Reload the device
- Generate a syslog message
- Generate an SNMP notification
- Use the default action for the system policy

VSH Script Policies

You can write policies in a VSH script, by using a text editor. Policies that are written using a VSH script have an event statement and action statement(s) just as other policies, and these policies can either augment or override system policies.

After you define your VSH script policy, copy it to the device and activate it.

Licensing Requirements for Embedded Event Manager

This feature does not require a license. Any feature not included in a license package is bundled with the Inspur INOS-CN image and is provided at no extra charge to you.

Prerequisites for Embedded Event Manager

You must have network-admin privileges to configure EEM.

Guidelines and Limitations for Embedded Event Manager

When you plan your EEM configuration, consider the following:

- The maximum number of configurable EEM policies is 500.
- Action statements within your user policy or overriding policy should not negate each other or adversely affect the associated system policy.
- If you want to allow a triggered event to process any default actions, you must configure the EEM policy to allow the default action. For example, if you match a command in a match statement, you must add the event-default action statement to the EEM policy or EEM does not allow the command to execute.
- An override policy that consists of an event statement and no action statement triggers no action and no notification of failures.
- An override policy without an event statement overrides all possible events in the system policy.
- In regular command expressions: all keywords must be expanded, and only the asterisk (*) symbol can be used to replace the arguments.
- EEM event correlation supports up to four event statements in a single policy. The event types can be the same or different, but only these event types are supported: cli, counter, snmp, syslog, and track.

- When more than one event statement is included in an EEM policy, each event statement must have a **tag** keyword with a unique tag argument.
- EEM event correlation does not override the system default policies.
- Default action execution is not supported for policies that are configured with tagged events.
- If your event specification matches a CLI pattern, you can use SSH-style wild card characters. For example, if you want to match all show commands, enter the **show *** command. Entering the **show . *** command does not work.
- If your event specification is a regular expression for a matching syslog message, you can use a proper regular expression. For example, if you want to detect ADMIN_DOWN events on any port where a syslog is generated, use **.ADMIN_DOWN.**. Entering the **ADMIN_DOWN** command does not work.
- In the event specification for a syslog, the regex does not match any syslog message that is generated as an action of an EEM policy.
- If an EEM event matches a **show** command in the CLI and you want the output for that **show** command to display on the screen (and to not be blocked by the EEM policy), you must specify the **event-default** command for the first action for the EEM policy.

Default Settings for Embedded Event Manager

Table 14: Default EEM Parameters

Parameters	Default
System Policies	Active

Configuring Embedded Event Manager

Defining an Environment Variable

Defining an environment variable is an optional step but is useful for configuring common values for repeated use in multiple policies.

Procedure

	Command or Action	Purpose
Step 1	configure terminal Example: switch# configure terminal switch(config)#	Enters global configuration mode.

	Command or Action	Purpose
Step 2	event manager environment <i>variable-name</i> <i>variable-value</i> Example: <pre>switch(config) # event manager environment emailto "admin@anyplace.com"</pre>	Creates an environment variable for EEM. The <i>variable-name</i> can be any case-sensitive, alphanumeric string up to 29 characters. The <i>variable-value</i> can be any quoted case-sensitive, alphanumeric string up to 39 characters.
Step 3	show event manager environment { <i>variable-name</i> all } Example: <pre>switch(config) # show event manager environment all</pre>	(Optional) Displays information about the configured environment variables.
Step 4	copy running-config startup-config Example: <pre>switch(config)# copy running-config startup-config</pre>	(Optional) Saves the change persistently through reboots and restarts by copying the running configuration to the startup configuration.

What to Do Next

Configure a User Policy.

Defining a User Policy Using the CLI

Procedure

	Command or Action	Purpose
Step 1	configure terminal Example: <pre>switch# configure terminal switch(config) #</pre>	Enters global configuration mode.
Step 2	event manager applet <i>applet-name</i> Example: <pre>switch(config)# event manager applet monitorShutdown switch(config-applet) #</pre>	Registers the applet with EEM and enters applet configuration mode. The <i>applet-name</i> can be any case-sensitive, alphanumeric string up to 29 characters.
Step 3	description <i>policy-description</i> Example: <pre>switch(config-applet) # description "Monitors interface shutdown."</pre>	(Optional) Configures a descriptive string for the policy. The string can be any alphanumeric string up to 80 characters. Enclose the string in quotation marks.

	Command or Action	Purpose
Step 4	event <i>event-statement</i> Example: switch(config-applet)# event cli match "shutdown"	Configures the event statement for the policy.
Step 5	tag <i>tag</i> { and andnot or } <i>tag</i> [and andnot or { <i>tag</i> }] { happens <i>occurs in seconds</i> } Example: switch(config-applet)# tag one or two happens 1 in 10000	(Optional) Correlates multiple events in the policy. The range for the <i>occurs</i> argument is from 1 to 4294967295. The range for the <i>seconds</i> argument is from 0 to 4294967295 seconds.
Step 6	action <i>number</i> [<i>number2</i>] <i>action-statement</i> Example: switch(config-applet)# action 1.0 cli show interface e 3/1	Configures an action statement for the policy. Repeat this step for multiple action statements.
Step 7	show event manager policy-state <i>name</i> [<i>module module-id</i>] Example: switch(config-applet)# show event manager policy-state monitorShutdown	(Optional) Displays information about the status of the configured policy.
Step 8	copy running-config startup-config Example: switch(config)# copy running-config startup-config	(Optional) Saves the change persistently through reboots and restarts by copying the running configuration to the startup configuration.

What to Do Next

Configure event statements and action statements.

Configuring Event Statements

Use one of the following commands in EEM configuration mode (config-applet) to configure an event statement:

Before You Begin

Define a user policy.

Procedure

	Command or Action	Purpose
Step 1	<p>event cli [tag tag] match <i>expression</i> [count repeats time seconds]</p> <p>Example: <pre>switch(config-applet) # event cli match "shutdown"</pre></p>	<p>Triggers an event if you enter a command that matches the regular expression.</p> <p>The tag tag keyword-argument pair identifies this specific event when multiple events are included in the policy.</p> <p>The <i>repeats</i> range is from 1 to 65000.</p> <p>The <i>time</i> range is from 0 to 4294967295, where 0 indicates no time limit.</p>
Step 2	<p>event counter [tag tag] name counter entry-val entry entry-op {eq ge gt le lt ne} {exit-val exit exit-op {eq ge gt le lt ne}}</p> <p>Example: <pre>switch(config-applet) # event counter name mycounter entry-val 20 gt</pre></p>	<p>Triggers an event if the counter crosses the entry threshold based on the entry operation. The event resets immediately. Optionally, you can configure the event to reset after the counter passes the exit threshold.</p> <p>The tag tag keyword-argument pair identifies this specific event when multiple events are included in the policy.</p> <p>The <i>counter</i> name can be any case-sensitive, alphanumeric string up to 28 characters.</p> <p>The <i>entry</i> and <i>exit</i> value ranges are from 0 to 2147483647.</p>
Step 3	<p>event fanabsent [fan number] time seconds</p> <p>Example: <pre>switch(config-applet) # event fanabsent time 300</pre></p>	<p>Triggers an event if a fan is removed from the device for more than the configured time, in seconds.</p> <p>The <i>number</i> range is from 1 to 1 and is module-dependent.</p> <p>The <i>seconds</i> range is from 10 to 64000.</p>
Step 4	<p>event fanbad [fan number] time seconds</p> <p>Example: <pre>switch(config-applet) # event fanbad time 3000</pre></p>	<p>Triggers an event if a fan fails for more than the configured time, in seconds.</p> <p>The <i>number</i> range is module-dependent.</p> <p>The <i>seconds</i> range is from 10 to 64000.</p>
Step 5	<p>event memory {critical minor severe}</p> <p>Example: <pre>switch(config-applet) # event memory critical</pre></p>	<p>Triggers an event if a memory threshold is crossed.</p>
Step 6	<p>event policy-default count repeats [time seconds]</p> <p>Example: <pre>switch(config-applet) # event policy-default count 3</pre></p>	<p>Uses the event configured in the system policy. Use this option for overriding policies.</p> <p>The <i>repeats</i> range is from 1 to 65000.</p> <p>The <i>seconds</i> range is from 0 to 4294967295, where 0 indicates no time limit.</p>

	Command or Action	Purpose
Step 7	<p>event snmp [tag tag] oid oid get-type {exact next} entry-op {eq ge gt le lt ne} entry-val entry [exit-comb {and or}] exit-op {eq ge gt le lt ne} exit-val exit exit-time time polling-interval interval</p> <p>Example: <pre>switch(config-applet) # event snmp oid 1.3.6.1.2.1.31.1.1.1.6 get-type next entry-op lt 300 entry-val 0 exit-op eq 400 exit-time 30 polling-interval 300</pre></p>	<p>Triggers an event if the SNMP OID crosses the entry threshold based on the entry operation. The event resets immediately, or optionally you can configure the event to reset after the counter passes the exit threshold. The OID is in dotted decimal notation.</p> <p>The tag tag keyword-argument pair identifies this specific event when multiple events are included in the policy.</p> <p>The <i>entry</i> and <i>exit</i> value ranges are from 0 to 18446744073709551615.</p> <p>The <i>time</i>, in seconds, is from 0 to 2147483647.</p> <p>The <i>interval</i>, in seconds, is from 0 to 2147483647.</p>
Step 8	<p>event sysmgr memory [module module-num] major major-percent minor minor-percent clear clear-percent</p> <p>Example: <pre>switch(config-applet) # event sysmgr memory minor 80</pre></p>	<p>Triggers an event if the specified system manager memory threshold is exceeded.</p> <p>The <i>percent</i> range is from 1 to 99.</p>
Step 9	<p>event temperature [module slot] [sensor number] threshold {any down up}</p> <p>Example: <pre>switch(config-applet) # event temperature module 2 threshold any</pre></p>	<p>Triggers an event if the temperature sensor exceeds the configured threshold.</p> <p>The <i>sensor</i> range is from 1 to 18.</p>
Step 10	<p>event track [tag tag] object-number state {any down up}</p> <p>Example: <pre>switch(config-applet) # event track 1 state down</pre></p>	<p>Triggers an event if the tracked object is in the configured state.</p> <p>The tag tag keyword-argument pair identifies this specific event when multiple events are included in the policy.</p> <p>The <i>object-number</i> range is from 1 to 500.</p>

What to Do Next

Configure action statements.

If you have already configured action statements or choose not to, complete any of the optional tasks:

- Define a policy using a VSH script. Then, register and activate a VSH script policy.
- Configure memory thresholds
- Configure the syslog as an EEM publisher.
- Verify your EEM configuration.

Configuring Action Statements

You can configure an action by using one of the following commands in EEM configuration mode (config-applet):



Note

If you want to allow a triggered event to process any default actions, you must configure the EEM policy to allow the default action.

For example, if you match a command in a match statement, you must add the event-default action statement to the EEM policy or EEM does not allow the command to execute. You can use the **terminal event-manager bypass** command to allow all EEM policies with matches to execute the command.

Before You Begin

Define a user policy.

Procedure

	Command or Action	Purpose
Step 1	action <i>number</i> [. <i>number2</i>] cli <i>command1</i> [<i>command2</i> .] [local] Example: <pre>switch(config-applet) # action 1.0 cli "show interface e 3/1"</pre>	Runs the configured commands. You can optionally run the commands on the module where the event occurred. The action label is in the format <i>number1.number2</i> . The <i>number</i> can be any number from 1 to 16 digits. The range for <i>number2</i> is from 0 to 9.
Step 2	action <i>number</i> [. <i>number2</i>] counter name <i>counter value val op {dec inc nop set}</i> Example: <pre>switch(config-applet) # action 2.0 counter name mycounter value 20 op inc</pre>	Modifies the counter by the configured value and operation. The action label is in the format <i>number1.number2</i> . The <i>number</i> can be any number from 1 to 16 digits. The range for <i>number2</i> is from 0 to 9. The <i>counter</i> can be any case-sensitive, alphanumeric string up to 28 characters. The <i>val</i> can be an integer from 0 to 2147483647 or a substituted parameter.
Step 3	action <i>number</i> [. <i>number2</i>] event-default Example: <pre>switch(config-applet) # action 1.0 event-default</pre>	Completes the default action for the associated event. The action label is in the format <i>number1.number2</i> . The <i>number</i> can be any number from 1 to 16 digits. The range for <i>number2</i> is from 0 to 9.
Step 4	action <i>number</i> [. <i>number2</i>] policy-default Example: <pre>switch(config-applet) # action 1.0 policy-default</pre>	Completes the default action for the policy that you are overriding. The action label is in the format <i>number1.number2</i> . The <i>number</i> can be any number from 1 to 16 digits.

	Command or Action	Purpose
		The range for <i>number2</i> is from 0 to 9.
Step 5	action <i>number</i> [. <i>number2</i>] reload [module <i>slot</i> [- <i>slot</i>]] Example: <pre>switch(config-applet) # action 1.0 reload module 3-5</pre>	Forces one or more modules to the entire system to reload. The action label is in the format <i>number1.number2</i> . The <i>number</i> can be any number from 1 to 16 digits. The range for <i>number2</i> is from 0 to 9.
Step 6	action <i>number</i> [. <i>number2</i>] snmp-trap [intdata1 <i>integer-data1</i>] [intdata2 <i>integer-data2</i>] [strdata <i>string-data</i>] Example: <pre>switch(config-applet) # action 1.0 snmp-trap strdata "temperature problem"</pre>	Sends an SNMP trap with the configured data. The action label is in the format <i>number1.number2</i> . The <i>number</i> can be any number from 1 to 16 digits. The range for <i>number2</i> is from 0 to 9. The <i>data</i> elements can be any number up to 80 digits. The <i>string</i> can be any alphanumeric string up to 80 characters.
Step 7	action <i>number</i> [. <i>number2</i>] syslog [priority <i>prio-val</i>] msg <i>error-message</i> Example: <pre>switch(config-applet) # action 1.0 syslog priority notifications msg "cpu high"</pre>	Sends a customized syslog message at the configured priority. The action label is in the format <i>number1.number2</i> . The <i>number</i> can be any number from 1 to 16 digits. The range for <i>number2</i> is from 0 to 9. The <i>error-message</i> can be any quoted alphanumeric string up to 80 characters.

What to Do Next

Configure event statements.

If you have already configured event statements or choose not to, complete any of the optional tasks:

- Define a policy using a VSH script. Then, register and activate a VSH script policy.
- Configure memory thresholds
- Configure the syslog as an EEM publisher.
- Verify your EEM configuration.

Defining a Policy Using a VSH Script

This is an optional task. Complete the following steps if you are using a VSH script to write EEM policies:

Procedure

-
- Step 1** In a text editor, list the commands that define the policy.
- Step 2** Name the text file and save it.
- Step 3** Copy the file to the following system directory: `bootflash://eem/user_script_policies`
-

What to Do Next

Register and activate a VSH script policy.

Registering and Activating a VSH Script Policy

This is an optional task. Complete the following steps if you are using a VSH script to write EEM policies.

Before You Begin

Define a policy using a VSH script and copy the file to the system directory.

Procedure

	Command or Action	Purpose
Step 1	configure terminal Example: <code>switch# configure terminal</code> <code>switch(config)#</code>	Enters global configuration mode.
Step 2	event manager policy <i>policy-script</i> Example: <code>switch(config)# event manager policy</code> <code>moduleScript</code>	Registers and activates an EEM script policy. The <i>policy-script</i> can be any case-sensitive, alphanumeric string up to 29 characters.
Step 3	event manager policy internal <i>name</i> Example: <code>switch(config)# event manager policy</code> <code>internal moduleScript</code>	(Optional) Registers and activates an EEM script policy. The <i>policy-script</i> can be any case-sensitive alphanumeric string up to 29 characters.
Step 4	copy running-config startup-config Example: <code>switch(config)# copy running-config</code> <code>startup-config</code>	(Optional) Saves the change persistently through reboots and restarts by copying the running configuration to the startup configuration.

What to Do Next

Complete any of the following, depending on your system requirements:

- Configure memory thresholds.
- Configure the syslog as an EEM publisher.
- Verify your EEM configuration.

Overriding a System Policy

Procedure

	Command or Action	Purpose
Step 1	configure terminal Example: <pre>switch# configure terminal switch(config)#</pre>	Enters global configuration mode.
Step 2	show event manager policy-state <i>system-policy</i> Example: <pre>switch(config-applet)# show event manager policy-state __ethpm_link_flap Policy __ethpm_link_flap Cfg count : 5 Cfg time interval : 10.000000 (seconds) Hash default, Count 0</pre>	(Optional) Displays information about the system policy that you want to override, including thresholds. Use the show event manager system-policy command to find the system policy names.
Step 3	event manager applet <i>applet-name</i> override <i>system-policy</i> Example: <pre>switch(config-applet)# event manager applet ethport override __ethpm_link_flap switch(config-applet)#</pre>	Overrides a system policy and enters applet configuration mode. The <i>applet-name</i> can be any case-sensitive, alphanumeric string up to 80 characters. The <i>system-policy</i> must be one of the system policies.
Step 4	description <i>policy-description</i> Example: <pre>switch(config-applet)# description "Overrides link flap policy"</pre>	Configures a descriptive string for the policy. The <i>policy-description</i> can be any case-sensitive, alphanumeric string up to 80 characters, but it must be enclosed in quotation marks.
Step 5	event <i>event-statement</i> Example: <pre>switch(config-applet)# event policy-default count 2 time 1000</pre>	Configures the event statement for the policy.
Step 6	section <i>number</i> <i>action-statement</i> Example: <pre>switch(config-applet)# action 1.0 syslog priority warnings msg "Link is flapping."</pre>	Configures an action statement for the policy. For multiple action statements, repeat this step.

	Command or Action	Purpose
Step 7	show event manager policy-state <i>name</i> Example: switch(config-applet)# show event manager policy-state ethport	(Optional) Displays information about the configured policy.
Step 8	copy running-config startup-config Example: switch(config)# copy running-config startup-config	(Optional) Saves the change persistently through reboots and restarts by copying the running configuration to the startup configuration.

Configuring Syslog as an EEM Publisher

Configuring syslog as an EEM publisher allows you to monitor syslog messages from the switch.



Note

The maximum number of searchable strings to monitor syslog messages is 10.

Before You Begin

- Confirm that EEM is available for registration by the syslog.
- Confirm that the syslog daemon is configured and executed.

Procedure

	Command or Action	Purpose
Step 1	configure terminal Example: switch# configure terminal switch(config)#	Enters global configuration mode.
Step 2	event manager applet <i>applet-name</i> Example: switch(config)# event manager applet abc switch (config-applet)#	Registers an applet with EEM and enters applet configuration mode.
Step 3	event syslog [tag <i>tag</i>] { occurs <i>number</i> period <i>seconds</i> pattern <i>msg-text</i> priority <i>priority</i> } Example: switch(config-applet)# event syslog occurs 10	Registers an applet with EEM and enters applet configuration mode.

	Command or Action	Purpose
Step 4	copy running-config startup-config Example: <pre>switch(config)# copy running-config startup-config</pre>	(Optional) Saves the change persistently through reboots and restarts by copying the running configuration to the startup configuration.

What to Do Next

Verify your EEM configuration.

Verifying the Embedded Event Manager Configuration

Use one of the following commands to verify the configuration:

Command	Purpose
show event manager environment [<i>variable-name</i> all]	Displays information about the event manager environment variables.
show event manager event-types [<i>event</i> all module slot]	Displays information about the event manager event types.
show event manager history events [detail] [maximum num-events] [severity {catastrophic minor moderate severe}]	Displays the history of events for all policies.
show event manager policy-state <i>policy-name</i>	Displays information about the policy state, including thresholds.
show event manager script system [<i>policy-name</i> all]	Displays information about the script policies.
show event manager system-policy [all]	Displays information about the predefined system policies.
show running-config eem	Displays information about the running configuration for EEM.
show startup-config eem	Displays information about the startup configuration for EEM.

Configuration Examples for Embedded Event Manager

The following example shows how to override the `__lcm_module_failure` system policy by changing the threshold for only module 3 hitless upgrade failures. It also sends a syslog message. The settings in the system policy, `__lcm_module_failure`, apply in all other cases.

```
event manager applet example2 override __lcm_module_failure
event module-failure type hitless-upgrade-failure module 3 count 2
  action 1 syslog priority errors msg module 3 "upgrade is not a hitless upgrade!"
  action 2 policy-default
```

The following example shows how to override the `__ethpm_link_flap` system policy and shut down the interface:

```
event manager applet ethport override __ethpm_link_flap
  event policy-default count 2 time 1000
  action 1 cli conf t
  action 2 cli int et1/1
  action 3 cli no shut
```

The following example shows how to create an EEM policy that allows the command to execute but triggers an SNMP notification when a user enters configuration mode on the device:

```
event manager applet TEST
  event cli match "conf t"
  action 1.0 snmp-trap strdata "Configuration change"
  action 2.0 event-default
```



Note

You must add the **event-default** action statement to the EEM policy or EEM does not allow the command to execute.

The following example shows how to correlate multiple events in an EEM policy and execute the policy based on a combination of the event triggers. In this example, the EEM policy is triggered if one of the specified syslog patterns occurs within 120 seconds.

```
event manager applet eem-correlate
  event syslog tag one pattern "copy bootflash:.* running-config.*"
  event syslog tag two pattern "copy run start"
  event syslog tag three pattern "hello"
  tag one or two or three happens 1 in 120
  action 1.0 reload module 1
```





CHAPTER 12

Configuring System Message Logging

This chapter contains the following sections:

- [Information About System Message Logging, page 127](#)
- [Licensing Requirements for System Message Logging, page 128](#)
- [Guidelines and Limitations for System Message Logging, page 128](#)
- [Default Settings for System Message Logging, page 129](#)
- [Configuring System Message Logging, page 129](#)
- [Verifying the System Message Logging Configuration, page 142](#)

Information About System Message Logging

You can use system message logging to control the destination and to filter the severity level of messages that system processes generate. You can configure logging to terminal sessions, a log file, and syslog servers on remote systems.

System message logging is based on [RFC 3164](#).

By default, the Inspur CN6000 device outputs messages to terminal sessions.

By default, the switch logs system messages to a log file.

The following table describes the severity levels used in system messages. When you configure the severity level, the system outputs messages at that level and lower.

Table 16: System Message Severity Levels

Level	Description
0 – emergency	System unusable
1 – alert	Immediate action needed
2 – critical	Critical condition

Level	Description
3 – error	Error condition
4 – warning	Warning condition
5 – notification	Normal but significant condition
6 – informational	Informational message only
7 – debugging	Appears during debugging only

The switch logs the most recent 100 messages of severity 0, 1, or 2 to the NVRAM log. You cannot configure logging to the NVRAM.

You can configure which system messages should be logged based on the facility that generated the message and its severity level.

Syslog Servers

Syslog servers run on remote systems that are configured to log system messages based on the syslog protocol. You can configure the Inspur CN6000 Series switch to send logs to up to eight syslog servers.

To support the same configuration of syslog servers on all switches in a fabric, you can use Fabric Services (FS) to distribute the syslog server configuration.



Note

When the switch first initializes, messages are sent to syslog servers only after the network is initialized.

Licensing Requirements for System Message Logging

Product	License Requirement
Inspur INOS-CN	System message logging requires no license. Any feature not included in a license package is bundled with the Inspur INOS-CN image and is provided at no extra charge to you.

Guidelines and Limitations for System Message Logging

See the following guidelines and limitations for System Message Logging:

- System messages are logged to the console and to the logfile by default.
- There is a new syslog on Inspur CN6000 Series platforms to indicate the MAC collision events. The syslog message has the details, for example, the source MAC address, the VLANs, and the internal port number information. MAC collisions are normal and they are expected if the table usage crosses about 75% as observed on various setups. See the following example of the syslog: 2017 Oct 02 06:20:37 switch%-SLOT1-5-BCM_L2_HASH_COLLISION: L2 ENTRY unit=0 mac=00:11:11:f7:46:40 vlan=1998 port=0x0800082e.

Default Settings for System Message Logging

The following table lists the default settings for system message logging parameters.

Table 17: Default System Message Logging Parameters

Parameters	Default
Console logging	Enabled at severity level 2
Monitor logging	Enabled at severity level 2
Log file logging	Enabled to log messages at severity level 5
Module logging	Enabled at severity level 5
Facility logging	Enabled
Time-stamp units	Seconds
Syslog server logging	Disabled
Syslog server configuration distribution	Disabled

Configuring System Message Logging

Configuring System Message Logging to Terminal Sessions

You can configure the switch to log messages by their severity level to console, Telnet, and Secure Shell sessions.

By default, logging is enabled for terminal sessions.

Procedure

	Command or Action	Purpose
Step 1	switch# terminal monitor	Copies syslog messages from the console to the current terminal session.
Step 2	switch# configure terminal	Enters global configuration mode.
Step 3	switch(config)# logging console [severity-level]	<p>Enables the switch to log messages to the console session based on a specified severity level or higher (a lower number value indicates a higher severity level). Severity levels range from 0 to 7:</p> <ul style="list-style-type: none"> • 0 – emergency • 1 – alert • 2 – critical • 3 – error • 4 – warning • 5 – notification • 6 – informational • 7 – debugging <p>If the severity level is not specified, the default of 2 is used.</p>
Step 4	switch(config)# no logging console [severity-level]	(Optional) Disables logging messages to the console.
Step 5	switch(config)# logging monitor [severity-level]	<p>Enables the switch to log messages to the monitor based on a specified severity level or higher (a lower number value indicates a higher severity level). Severity levels range from 0 to 7:</p> <ul style="list-style-type: none"> • 0 – emergency • 1 – alert • 2 – critical • 3 – error • 4 – warning • 5 – notification • 6 – informational • 7 – debugging <p>If the severity level is not specified, the default of 2 is used. The configuration applies to Telnet and SSH sessions.</p>

	Command or Action	Purpose
Step 6	switch(config)# no logging monitor [<i>severity-level</i>]	(Optional) Disables logging messages to Telnet and SSH sessions.
Step 7	switch# show logging console	(Optional) Displays the console logging configuration.
Step 8	switch# show logging monitor	(Optional) Displays the monitor logging configuration.
Step 9	switch# copy running-config startup-config	(Optional) Copies the running configuration to the startup configuration.

The following example shows how to configure a logging level of 3 for the console:

```
switch# configure terminal
switch(config)# logging console 3
```

The following example shows how to display the console logging configuration:

```
switch# show logging console
Logging console:                               enabled (Severity: error)
```

The following example shows how to disable logging for the console:

```
switch# configure terminal
switch(config)# no logging console
```

The following example shows how to configure a logging level of 4 for the terminal session:

```
switch# terminal monitor
switch# configure terminal
switch(config)# logging monitor 4
```

The following example shows how to display the terminal session logging configuration:

```
switch# show logging monitor
Logging monitor:                               enabled (Severity: warning)
```

The following example shows how to disable logging for the terminal session:

```
switch# configure terminal
switch(config)# no logging monitor
```

Configuring System Message Logging to a File

You can configure the switch to log system messages to a file. By default, system messages are logged to the file log:messages.

Procedure

	Command or Action	Purpose
Step 1	switch# configure terminal	Enters global configuration mode.

	Command or Action	Purpose
Step 2	switch(config)# logging logfile <i>logfile-name severity-level [size bytes]</i>	Configures the name of the log file used to store system messages and the minimum severity level to log. You can optionally specify a maximum file size. The default severity level is 5 and the file size is 4194304. Severity levels range from 0 to 7: <ul style="list-style-type: none"> • 0 – emergency • 1 – alert • 2 – critical • 3 – error • 4 – warning • 5 – notification • 6 – informational • 7 – debugging The file size is from 4096 to 10485760 bytes.
Step 3	switch(config)# no logging logfile <i>[logfile-name severity-level [size bytes]]</i>	(Optional) Disables logging to the log file. You can optionally specify a maximum file size. The default severity level is 5 and the file size is 4194304.
Step 4	switch# show logging info	(Optional) Displays the logging configuration. You can optionally specify a maximum file size. The default severity level is 5 and the file size is 4194304.
Step 5	switch# copy running-config startup-config	(Optional) Copies the running configuration to the startup configuration.

The following example shows how to configure a switch to log system messages to a file:

```
switch# configure terminal
switch(config)# logging logfile my_log 6 size 4194304
```

The following example shows how to display the logging configuration (some of the output has been removed for brevity):

```
switch# show logging info
Logging console:          enabled (Severity: debugging)
Logging monitor:         enabled (Severity: debugging)
Logging timestamp:       Seconds
Logging server:           disabled
Logging logfile:         enabled
                        Name - my log: Severity - informational Size - 4194304
Facility                 Default Severity          Current Session Severity
-----                 -
aaa                      3                          3
```

```

aclmgr          3          3
afm             3          3
altos          3          3
auth           0          0
authpriv       3          3
bootvar        5          5
callhome       2          2
capability     2          2
cdp            2          2
cert enroll    2          2
...
    
```

Configuring Module and Facility Messages Logging

You can configure the severity level and time-stamp units of messages logged by modules and facilities.

Procedure

	Command or Action	Purpose
Step 1	switch# configure terminal	Enters global configuration mode.
Step 2	switch(config)# logging module <i>[severity-level]</i>	<p>Enables module log messages that have the specified severity level or higher. Severity levels range from 0 to 7:</p> <ul style="list-style-type: none"> • 0 – emergency • 1 – alert • 2 – critical • 3 – error • 4 – warning • 5 – notification • 6 – informational • 7 – debugging <p>If the severity level is not specified, the default of 5 is used.</p>
Step 3	switch(config)# logging level facility <i>severity-level</i>	<p>Enables logging messages from the specified facility that have the specified severity level or higher. Severity levels from 0 to 7:</p> <ul style="list-style-type: none"> • 0 – emergency • 1 – alert • 2 – critical • 3 – error • 4 – warning • 5 – notification • 6 – informational • 7 – debugging

	Command or Action	Purpose
		To apply the same severity level to all facilities, use the all facility. For defaults, see the show logging level command. Note You cannot configure the logging level for the BCM_USD, ETHPC, FWM, and NOHMS processes. For the BCM_USD process, use attach module 1 command and then configure the logging level. Note If the default severity and the current session severity of a component is same, then it is expected to not see the logging level for the component in the running configuration. The default logging level is not displayed in the running configuration, but it is displayed in the show logging level command.
Step 4	switch(config)# no logging module [<i>severity-level</i>]	(Optional) Disables module log messages.
Step 5	switch(config)# no logging level [<i>facility severity-level</i>]	(Optional) Resets the logging severity level for the specified facility to its default level. If you do not specify a facility and severity level, the switch resets all facilities to their default levels.
Step 6	switch# show logging module	(Optional) Displays the module logging configuration.
Step 7	switch# show logging level [<i>facility</i>]	(Optional) Displays the logging level configuration and the system default level by facility. If you do not specify a facility, the switch displays levels for all facilities.
Step 8	switch# copy running-config startup-config	(Optional) Copies the running configuration to the startup configuration.

The following example shows how to configure the severity level of module and specific facility messages:

```
switch# configure terminal
switch(config)# logging module 3
switch(config)# logging level aaa 2
```

Configuring Logging Timestamps

You can configure the time-stamp units of messages logged by the Inspur CN6000Series switch.

Procedure

	Command or Action	Purpose
Step 1	switch# configure terminal	Enters global configuration mode.
Step 2	switch(config)# logging timestamp { microseconds milliseconds seconds }	Sets the logging time-stamp units. By default, the units are seconds.
Step 3	switch(config)# no logging timestamp { microseconds milliseconds seconds }	(Optional) Resets the logging time-stamp units to the default of seconds.
Step 4	switch# show logging timestamp	(Optional) Displays the logging time-stamp units configured.
Step 5	switch# copy running-config startup-config	(Optional) Copies the running configuration to the startup configuration.

The following example shows how to configure the time-stamp units of messages:

```
switch# configure terminal
switch(config)# logging timestamp milliseconds
switch(config)# exit
switch# show logging timestamp
Logging timestamp:                Milliseconds
```

Configuring the ACL Logging Cache

Procedure

	Command or Action	Purpose
Step 1	switch# configure terminal	Enters global configuration mode.
Step 2	switch(config)# logging ip access-list cache entries <i>num_entries</i>	Sets the maximum number of log entries cached in software. The range is from 0 to 1000000 entries. The default value is 8000 entries.
Step 3	switch(config)# logging ip access-list cache interval <i>seconds</i>	Sets the number of seconds between log updates. Also if an entry is inactive for this duration, it is removed from the cache. The range is from 5 to 86400 seconds. The default value is 300 seconds.
Step 4	switch(config)# logging ip access-list cache threshold <i>num_packets</i>	Sets the number of packet matches before an entry is logged. The range is from 0 to 1000000 packets. The default value is 0 packets, which means that logging is not triggered by the number of packet matches.

	Command or Action	Purpose
Step 5	switch(config)# copy running-config startup-config	(Optional) Saves the change persistently through reboots and restarts by copying the running configuration to the startup configuration.

The following example show how to set the maximum number of log entries to 5000, the interval to 120 seconds, and the threshold to 500000:

```
switch# configure terminal
switch(config)# logging ip access-list cache entries 5000
switch(config)# logging ip access-list cache interval 120
switch(config)# logging ip access-list cache threshold 500000
switch(config)# copy running-config startup-config
```

Applying ACL Logging to an Interface

Before You Begin

- Create an IP access list with at least one access control entry (ACE) configured for logging.
- Configure the ACL logging cache.
- Configure the ACL log match level.

Procedure

	Command or Action	Purpose
Step 1	switch# configure terminal	Enters global configuration mode.
Step 2	switch(config)# interface mgmt0	Specifies the mgmt0 interface.
Step 3	switch(config-if)# ip access-group name in	Enables ACL logging on ingress traffic for the specified interface.
Step 4	switch(config-if)# copy running-config startup-config	(Optional) Saves the change persistently through reboots and restarts by copying the running configuration to the startup configuration.

The following example shows how to apply the mgmt0 interface with the logging specified in acl1 for all ingress traffic:

```
switch# configure terminal
switch(config)# interface mgmt0
switch(config-if)# ip access-group acl1 in
switch(config-if)# copy running-config startup-config
```

Configuring a Logging Source-Interface

You can set all system logging (syslog) messages that are sent to syslog servers to contain the same IP address as the source address, regardless of which interface the syslog message uses to exit the router. The system allows a user-configured source-IP in a syslog packet specified by the source-interface.



Note If a valid IP address is not assigned, the syslog is thrown and messages are sent out carrying the exit interfaces IP address.

Procedure

	Command or Action	Purpose
Step 1	switch# configure terminal	Enters global configuration mode.
Step 2	switch(config)# [no] logging source-interface [ethernet slot/port loopback interface-number mgmt interface-number port-channel port channel-number vlan interface-number tunnel interface-number]	<ul style="list-style-type: none"> • ethernet—The range for the Ethernet option source-interface is from 1 to 253. • loopback—The range for the loopback option source-interface is from 1 to 1023. • mgmt—The interface number for the management option source-interface is 0. • port-channel—The range for the port channel option source-interface is from 1 to 4096.
Step 3	switch(config)# copy running-config startup-config	(Optional) Saves the change persistently through reboots and restarts by copying the running configuration to the startup configuration.

The following example shows how to configure the source-interface as the ethernet interface:

```
switch# configure terminal
switch(config)# logging source-interface ethernet 2/1
switch(config)# copy running-config startup-config
```

Configuring the ACL Log Match Level

Procedure

	Command or Action	Purpose
Step 1	switch# configure terminal	Enters global configuration mode.

	Command or Action	Purpose
Step 2	switch(config)# aclog match-log-level <i>number</i>	Specifies the logging level to match for entries to be logged in the ACL log (aclog). The <i>number</i> is a value from 0 to 7. The default is 6. Note For log messages to be entered in the logs, the logging level for the ACL log facility (aclog) and the logging severity level for the logfile must be greater than or equal to the ACL log match log level setting. For more information, see Configuring Module and Facility Messages Logging , on page 133 and Configuring System Message Logging to a File , on page 131.
Step 3	switch(config)# copy running-config startup-config	(Optional) Saves the change persistently through reboots and restarts by copying the running configuration to the startup configuration.

Configuring Syslog Servers

You can configure up to eight syslog servers that reference remote systems where you want to log system messages.

Procedure

	Command or Action	Purpose
Step 1	configure terminal Example: switch# configure terminal switch(config)#	Enters global configuration mode.
Step 2	logging server <i>host</i> [<i>severity-level</i>] [use-vrf <i>vrf-name</i> [facility <i>facility</i>]]] Example: switch(config)# logging server 172.28.254.254 5 use-vrf default facility local3	Configures a host to receive syslog messages. <ul style="list-style-type: none"> • The <i>host</i> argument identifies the hostname or the IPv4 or IPv6 address of the syslog server host. • The <i>severity-level</i> argument limits the logging of messages to the syslog server to a specified level. Severity levels range from 0 to 7. See Table 16: System Message Severity Levels, on page 127. • The use vrf <i>vrf-name</i> keyword and argument identify the <i>default</i> or <i>management</i> values for the virtual routing and forwarding (VRF) name. If a specific VRF is not identified, management is the default. However, if management is configured, it will not be listed in the output of the show-running command because it is the default. If a specific VRF is configured, the show-running command output will list the VRF for each server.

	Command or Action	Purpose
		<p>Note The current Fabric Services (FS) distribution does not support VRF. If FS distribution is enabled, the logging server configured with the default VRF is distributed as the management VRF.</p> <ul style="list-style-type: none"> The facility argument names the syslog facility type. The default outgoing facility is local7. <p>Note Debugging is a CLI facility but the debug syslogs are not sent to the server.</p>
Step 3	<p>no logging server <i>host</i></p> <p>Example: switch(config)# no logging server 172.28.254.254 5</p>	<p>(Optional) Removes the logging server for the specified host.</p>
Step 4	<p>show logging server</p> <p>Example: switch# show logging server</p>	<p>(Optional) Displays the syslog server configuration.</p>
Step 5	<p>copy running-config startup-config</p> <p>Example: switch(config)# copy running-config startup-config</p>	<p>(Optional) Saves the change persistently through reboots and restarts by copying the running configuration to the startup configuration.</p>

The following examples show how to configure a syslog server:

```
switch# configure terminal
switch(config)# logging server 172.28.254.254 5 use-vrf default facility local3
switch# configure terminal
switch(config)# logging server 172.28.254.254 5 use-vrf management facility local3
```

Configuring syslog on a UNIX or Linux System

You can configure a syslog server on a UNIX or Linux system by adding the following line to the /etc/syslog.conf file:

```
facility.level <five tab characters> action
```

The following table describes the syslog fields that you can configure.

Table 18: syslog Fields in syslog.conf

Field	Description
Facility	Creator of the message, which can be auth, authpriv, cron, daemon, kern, lpr, mail, mark, news, syslog, user, local0 through local7, or an asterisk (*) for all. These facility designators allow you to control the destination of messages based on their origin. Note Check your configuration before using a local facility.
Level	Minimum severity level at which messages are logged, which can be debug, info, notice, warning, err, crit, alert, emerg, or an asterisk (*) for all. You can use none to disable a facility.
Action	Destination for messages, which can be a filename, a hostname preceded by the at sign (@), or a comma-separated list of users or an asterisk (*) for all logged-in users.

Procedure

Step 1 Log debug messages with the local7 facility in the file /var/log/myfile.log by adding the following line to the /etc/syslog.conf file:

```
debug.local7                /var/log/myfile.log
```

Step 2 Create the log file by entering these commands at the shell prompt:

```
$ touch /var/log/myfile.log
$ chmod 666 /var/log/myfile.log
```

Step 3 Make sure that the system message logging daemon reads the new changes by checking myfile.log after entering this command:

```
$ kill -HUP ~cat /etc/syslog.pid~
```

Configuring syslog Server Configuration Distribution

You can distribute the syslog server configuration to other switches in the network by using the Fabric Services (FS) infrastructure.

After you enable syslog server configuration distribution, you can modify the syslog server configuration and view the pending changes before committing the configuration for distribution. As long as distribution is enabled, the switch maintains pending changes to the syslog server configuration.



Note If the switch is restarted, the syslog server configuration changes that are kept in volatile memory might get lost.

Before You Begin

You must have configured one or more syslog servers.

Procedure

	Command or Action	Purpose
Step 1	switch# configure terminal	Enters global configuration mode.
Step 2	switch(config)# logging distribute	Enables distribution of the syslog server configuration to network switches using the FS infrastructure. By default, distribution is disabled.
Step 3	switch(config)# logging commit	Commits the pending changes to the syslog server configuration for distribution to the switches in the fabric.
Step 4	switch(config)# logging abort	Cancels the pending changes to the syslog server configuration.
Step 5	switch(config)# no logging distribute	(Optional) Disables the distribution of the syslog server configuration to network switches using the FS infrastructure. You cannot disable distribution when configuration changes are pending. See the logging commit and logging abort commands. By default, distribution is disabled.
Step 6	switch# show logging pending	(Optional) Displays the pending changes to the syslog server configuration.
Step 7	switch# show logging pending-diff	(Optional) Displays the differences from the current syslog server configuration to the pending changes of the syslog server configuration.
Step 8	switch# copy running-config startup-config	(Optional) Copies the running configuration to the startup configuration.

Displaying and Clearing Log Files

You can display or clear messages in the log file and the NVRAM.

Procedure

	Command or Action	Purpose
Step 1	switch# show logging last <i>number-lines</i>	Displays the last number of lines in the logging file. You can specify from 1 to 9999 for the last number of lines.
Step 2	switch# show logging logfile [start-time yyyy mmm dd hh:mm:ss] [end-time yyyy mmm dd hh:mm:ss]	Displays the messages in the log file that have a time stamp within the span entered. If you do not enter an end time, the current time is used. You enter three characters for the month time field and digits for the year and day time fields.
Step 3	switch# show logging nvram [last <i>number-lines</i>]	Displays the messages in the NVRAM. To limit the number of lines displayed, you can enter the last number of lines to display. You can specify from 1 to 100 for the last number of lines.
Step 4	switch# clear logging logfile	Clears the contents of the log file.
Step 5	switch# clear logging nvram	Clears the logged messages in NVRAM.

The following example shows how to display messages in a log file:

```
switch# show logging last 40
switch# show logging logfile start-time 2017 oct 2 15:10:0
switch# show logging nvram last 10
```

The following example shows how to clear messages in a log file:

```
switch# clear logging logfile
switch# clear logging nvram
```

Verifying the System Message Logging Configuration

Use these commands to verify system message logging configuration information:

Command	Purpose
show logging console	Displays the console logging configuration.
show logging info	Displays the logging configuration.
show logging ip access-list cache	Displays the IP access list cache.
show logging ip access-list cache detail	Displays detailed information about the IP access list cache.
show logging ip access-list status	Displays the status of the IP access list cache.
show logging last <i>number-lines</i>	Displays the last number of lines of the log file.

Command	Purpose
show logging level [<i>facility</i>]	Displays the facility logging severity level configuration.
show logging logfile [start-time <i>yyyy mmm dd hh:mm:ss</i>] [end-time <i>yyyy mmm dd hh:mm:ss</i>]	Displays the messages in the log file.
show logging module	Displays the module logging configuration.
show logging monitor	Displays the monitor logging configuration.
show logging nvram [<i>last number-lines</i>]	Displays the messages in the NVRAM log.
show logging pending	Displays the syslog server pending distribution configuration.
show logging pending-diff	Displays the syslog server pending distribution configuration differences.
show logging server	Displays the syslog server configuration.
show logging session	Displays the logging session status.
show logging status	Displays the logging status.
show logging timestamp	Displays the logging time-stamp units configuration.
show running-config aclog	Displays the running configuration for the ACL log file.

Configuring Smart Call Home

This chapter contains the following sections:

- [Information About Smart Call Home, page 145](#)
- [Guidelines and Limitations for Smart Call Home, page 154](#)
- [Prerequisites for Smart Call Home, page 155](#)
- [Default Call Home Settings, page 155](#)
- [Configuring Smart Call Home, page 155](#)
- [Verifying the Smart Call Home Configuration, page 165](#)
- [Sample Syslog Alert Notification in Full-Text Format, page 166](#)
- [Sample Syslog Alert Notification in XML Format, page 166](#)

Information About Smart Call Home

Smart Call Home provides e-mail-based notification of critical system events. Inspur CN6000 Series switches provide a range of message formats for optimal compatibility with pager services, standard e-mail, or XML-based automated parsing applications. You can use this feature to page a network support engineer, e-mail a Network Operations Center, or use Smart Call Home services to automatically generate a case with the Technical Assistance Center (TAC).

If you have a service contract directly with Inspur, you can register your devices for the Smart Call Home service. Smart Call Home provides fast resolution of system problems by analyzing Smart Call Home messages sent from your devices and providing background information and recommendations. For issues that can be identified as known, particularly GOLD diagnostics failures, Automatic Service Requests will be generated by the Inspur TAC.

Smart Call Home offers the following features:

- Continuous device health monitoring and real-time diagnostic alerts.
- Analysis of Smart Call Home messages from your device and, where appropriate, Automatic Service Request generation, routed to the appropriate TAC team, including detailed diagnostic information to speed problem resolution.

- Secure message transport directly from your device or through a downloadable Transport Gateway (TG) aggregation point. You can use a TG aggregation point in cases that require support for multiple devices or in cases where security requirements mandate that your devices may not be connected directly to the Internet.
- Web-based access to Smart Call Home messages and recommendations, inventory and configuration information for all Smart Call Home devices, and field notices, security advisories, and end-of-life information.

Smart Call Home Overview

You can use Smart Call Home to notify an external entity when an important event occurs on your device. Smart Call Home delivers alerts to multiple recipients that you configure in destination profiles. Smart Call Home includes a fixed set of predefined alerts on your switch. These alerts are grouped into alert groups and CLI commands that are assigned to execute when an alert in an alert group occurs. The switch includes the command output in the transmitted Smart Call Home message.

The Smart Call Home feature offers the following:

- Automatic execution and attachment of relevant CLI command output.
- Multiple message format options such as the following:
 - Short Text—Text that is suitable for pagers or printed reports.
 - Full Text—Fully formatted message information that is suitable for human reading.
 - XML—Matching readable format that uses the Extensible Markup Language (XML) and the Adaptive Messaging Language (AML) XML schema definition (XSD). The XML format enables communication with the Inspur TAC.
- Multiple concurrent message destinations. You can configure up to 50 e-mail destination addresses for each destination profile.

Smart Call Home Destination Profiles

A Smart Call Home destination profile includes the following information:

- One or more alert groups—The group of alerts that trigger a specific Smart Call Home message if the alert occurs.
- One or more e-mail destinations—The list of recipients for the Smart Call Home messages that are generated by alert groups assigned to this destination profile.
- Message format—The format for the Smart Call Home message (short text, full text, or XML).
- Message severity level—The Smart Call Home severity level that the alert must meet before the switch generates a Smart Call Home message to all e-mail addresses in the destination profile. The switch does not generate an alert if the Smart Call Home severity level of the alert is lower than the message severity level set for the destination profile.

You can also configure a destination profile to allow periodic inventory update messages by using the inventory alert group that will send out periodic messages daily, weekly, or monthly.

Inspur CN6000Series switches support the following predefined destination profiles:

- InspurTAC-1—Supports the Inspur-TAC alert group in XML message format.
- full-text-destination—Supports the full text message format.
- short-text-destination—Supports the short text message format.

Smart Call Home Alert Groups

An alert group is a predefined subset of Smart Call Home alerts that are supported in all Inspur CN6000 devices. Alert groups allow you to select the set of Smart Call Home alerts that you want to send to a predefined or custom destination profile. The switch sends Smart Call Home alerts to e-mail destinations in a destination profile only if that Smart Call Home alert belongs to one of the alert groups associated with that destination profile and if the alert has a Smart Call Home message severity at or above the message severity set in the destination profile.

The following table lists the supported alert groups and the default CLI command output included in Smart Call Home messages generated for the alert group.

Table 19: Alert Groups and Executed Commands

Alert Group	Description	Executed Commands
Inspur-TAC	All critical alerts from the other alert groups destined for Smart Call Home.	Execute commands based on the alert group that originates the alert.
Diagnostic	Events generated by diagnostics.	show diagnostic result module all detail show moduleshow version show tech-support platform callhome
Supervisor hardware	Events related to supervisor modules.	show diagnostic result module all detail show moduleshow version show tech-support platform callhome
Linecard hardware	Events related to standard or intelligent switching modules.	show diagnostic result module all detail show moduleshow version show tech-support platform callhome

Alert Group	Description	Executed Commands
Configuration	Periodic events related to configuration.	show version show module show running-config all show startup-config
System	Events generated by a failure of a software system that is critical to unit operation.	show system redundancy status show tech-support
Environmental	Events related to power, fan, and environment-sensing elements such as temperature alarms.	show environment show logging last 1000 show module show version show tech-support platform callhome
Inventory	Inventory status that is provided whenever a unit is cold booted, or when FRUs are inserted or removed. This alert is considered a noncritical event, and the information is used for status and entitlement.	show module show version show license usage show inventory show sprom all show system uptime

Smart Call Home maps the syslog severity level to the corresponding Smart Call Home severity level for syslog port group messages.

You can customize predefined alert groups to execute additional **show** commands when specific events occur and send that **show** output with the Smart Call Home message.

You can add **show** commands only to full text and XML destination profiles. Short text destination profiles do not support additional **show** commands because they only allow 128 bytes of text.

Smart Call Home Message Levels

Smart Call Home allows you to filter messages based on their level of urgency. You can associate each destination profile (predefined and user defined) with a Smart Call Home message level threshold. The switch does not generate any Smart Call Home messages with a value lower than this threshold for the destination profile. The Smart Call Home message level ranges from 0 (lowest level of urgency) to 9 (highest level of urgency), and the default is 0 (the switch sends all messages).

Smart Call Home messages that are sent for syslog alert groups have the syslog severity level mapped to the Smart Call Home message level.



Note Smart Call Home does not change the syslog message level in the message text.

The following table shows each Smart Call Home message level keyword and the corresponding syslog level for the syslog port alert group.

Table 20: Severity and Syslog Level Mapping

Smart Call Home Level	Keyword	Syslog Level	Description
9	Catastrophic	N/A	Network-wide catastrophic failure.
8	Disaster	N/A	Significant network impact.
7	Fatal	Emergency (0)	System is unusable.
6	Critical	Alert (1)	Critical conditions that indicate that immediate attention is needed.
5	Major	Critical (2)	Major conditions.
4	Minor	Error (3)	Minor conditions.
3	Warning	Warning (4)	Warning conditions.
2	Notification	Notice (5)	Basic notification and informational messages.
1	Normal	Information (6)	Normal event signifying return to normal state.
0	Debugging	Debug (7)	Debugging messages.

Call Home Message Formats

Call Home supports the following message formats:

- Short text message format
- Common fields for all full text and XML messages
- Inserted fields for a reactive or proactive event message
- Inserted fields for an inventory event message
- Inserted fields for a user-generated test message

The following table describes the short text formatting option for all message types.

Table 21: Short Text Message Format

Data Item	Description
Device identification	Configured device name
Date/time stamp	Time stamp of the triggering event
Error isolation message	Plain English description of triggering event
Alarm urgency level	Error level such as that applied to a system message

The following table describes the common event message format for full text or XML.

Table 22: Common Fields for All Full Text and XML Messages

Data Item (Plain Text and XML)	Description (Plain Text and XML)	XML Tag (XML Only)
Time stamp	Date and time stamp of event in ISO time notation: <i>YYYY-MM-DD HH:MM:SS</i> <i>GMT+HH:MM</i>	/aml/header/time
Message name	Name of message. Specific event names are listed in the preceding table.	/aml/header/name
Message type	Name of message type, such as reactive or proactive.	/aml/header/type
Message group	Name of alert group, such as syslog.	/aml/header/group
Severity level	Severity level of message.	/aml/header/level
Source ID	Product type for routing.	/aml/header/source

Data Item (Plain Text and XML)	Description (Plain Text and XML)	XML Tag (XML Only)
Device ID	<p>Unique device identifier (UDI) for the end device that generated the message. This field should be empty if the message is nonspecific to a device. The format is <i>type@Sid@serial</i>:</p> <ul style="list-style-type: none"> • <i>type</i> is the product model number from backplane IDPROM. • <i>@</i> is a separator character. • <i>Sid</i> is C, identifying the serial ID as a chassis serial number. • <i>serial</i> is the number identified by the Sid field. <p>An example is WS-C6509@C@12345678</p>	/aml/ header/deviceID
Customer ID	Optional user-configurable field used for contract information or other ID by any support service.	/aml/ header/customerID
Contract ID	Optional user-configurable field used for contract information or other ID by any support service.	/aml/ header /contractID
Site ID	Optional user-configurable field used for Inspur-supplied site ID or other data meaningful to alternate support service.	/aml/ header/siteID

Data Item (Plain Text and XML)	Description (Plain Text and XML)	XML Tag (XML Only)
Server ID	<p>If the message is generated from the device, this is the unique device identifier (UDI) of the device.</p> <p>The format is <i>type@Sid@serial</i>:</p> <ul style="list-style-type: none"> • <i>type</i> is the product model number from backplane IDPROM. • @ is a separator character. • <i>Sid</i> is C, identifying the serial ID as a chassis serial number. • <i>serial</i> is the number identified by the Sid field. <p>An example is WS-C6509@C@12345678</p>	/aml/header/serverID
Message description	Short text that describes the error.	/aml/body/msgDesc
Device name	Node that experienced the event (hostname of the device).	/aml/body/sysName
Contact name	Name of person to contact for issues associated with the node that experienced the event.	/aml/body/sysContact
Contact e-mail	E-mail address of person identified as the contact for this unit.	/aml/body/sysContactEmail
Contact phone number	Phone number of the person identified as the contact for this unit.	/aml/body/sysContactPhoneNumber
Street address	Optional field that contains the street address for RMA part shipments associated with this unit.	/aml/body/sysStreetAddress
Model name	Model name of the device (the specific model as part of a product family name).	/aml/body/chassis/name
Serial number	Chassis serial number of the unit.	/aml/body/chassis/serialNo
Chassis part number	Top assembly number of the chassis.	/aml/body/chassis/partNo
Fields specific to a particular alert group message are inserted here.		

Data Item (Plain Text and XML)	Description (Plain Text and XML)	XML Tag (XML Only)
The following fields may be repeated if multiple CLI commands are executed for this alert group.		
Command output name	Exact name of the issued CLI command.	/aml/attachments/attachment/name
Attachment type	Specific command output.	/aml/attachments/attachment/type
MIME type	Either plain text or encoding type.	/aml/attachments/attachment/mime
Command output text	Output of command automatically executed.	/aml/attachments/attachment/atdata

The following table describes the reactive event message format for full text or XML.

Table 23: Inserted Fields for a Reactive or Proactive Event Message

Data Item (Plain Text and XML)	Description (Plain Text and XML)	XML Tag (XML Only)
Chassis hardware version	Hardware version of chassis.	/aml/body/chassis/hwVersion
Supervisor module software version	Top-level software version.	/aml/body/chassis/swVersion
Affected FRU name	Name of the affected FRU that is generating the event message.	/aml/body/fru/name
Affected FRU serial number	Serial number of the affected FRU.	/aml/body/fru/serialNo
Affected FRU part number	Part number of the affected FRU.	/aml/body/fru/partNo
FRU slot	Slot number of the FRU that is generating the event message.	/aml/body/fru/slot
FRU hardware version	Hardware version of the affected FRU.	/aml/body/fru/hwVersion
FRU software version	Software version(s) that is running on the affected FRU.	/aml/body/fru/swVersion

The following table describes the inventory event message format for full text or XML.

Table 24: Inserted Fields for an Inventory Event Message

Data Item (Plain Text and XML)	Description (Plain Text and XML)	XML Tag (XML Only)
Chassis hardware version	Hardware version of the chassis.	/aml/body/chassis/hwVersion

Data Item (Plain Text and XML)	Description (Plain Text and XML)	XML Tag (XML Only)
Supervisor module software version	Top-level software version.	/aml/body/chassis/swVersion
FRU name	Name of the affected FRU that is generating the event message.	/aml/body/fru/name
FRU s/n	Serial number of the FRU.	/aml/body/fru/serialNo
FRU part number	Part number of the FRU.	/aml/body/fru/partNo
FRU slot	Slot number of the FRU.	/aml/body/fru/slot
FRU hardware version	Hardware version of the FRU.	/aml/body/fru/hwVersion
FRU software version	Software version(s) that is running on the FRU.	/aml/body/fru/swVersion

The following table describes the user-generated test message format for full text or XML.

Table 25: Inserted Fields for a User-Generated Test Message

Data Item (Plain Text and XML)	Description (Plain Text and XML)	XML Tag (XML Only)
Process ID	Unique process ID.	/aml/body/process/id
Process state	State of process (for example, running or halted).	/aml/body/process/processState
Process exception	Exception or reason code.	/aml/body/process/exception

Guidelines and Limitations for Smart Call Home

- If there is no IP connectivity, or if the interface in the virtual routing and forwarding (VRF) instance to the profile destination is down, the switch cannot send Smart Call Home messages.
- Operates with any SMTP e-mail server.



Note The SNMP syscontact is not configured by default. You have to explicitly use the **snmp-server contact <sys-contact>** command to configure the SNMP syscontact. When this command is configured, the feature callhome gets enabled.

Prerequisites for Smart Call Home

- You must have e-mail server connectivity.
- You must have access to contact name (SNMP server contact), phone, and street address information.
- You must have IP connectivity between the switch and the e-mail server.
- You must have an active service contract for the device that you are configuring.

Default Call Home Settings

Table 26: Default Call Home Parameters

Parameters	Default
Destination message size for a message sent in full text format	4000000
Destination message size for a message sent in XML format	4000000
Destination message size for a message sent in short text format	4000
SMTP server port number if no port is specified	25
Alert group association with profile	All for full-text-destination and short-text-destination profiles. The inspur-tac alert group for the InspurTAC-1 destination profile
Format type	XML
Call Home message level	0 (zero)

Configuring Smart Call Home

Registering for Smart Call Home

Before You Begin

- Know the sMARTnet contract number for your switch
- Know your e-mail address

- Know your Inspur.com ID

Procedure

Step 1 In a browser, navigate to the Smart Call Home web page:

Step 2 Under **Getting Started**, follow the directions to register Smart Call Home.

What to Do Next

Configure contact information.

Configuring Contact Information

You must configure the e-mail, phone, and street address information for Smart Call Home. You can optionally configure the contract ID, customer ID, site ID, and switch priority information.

Procedure

	Command or Action	Purpose
Step 1	switch# configure terminal	Enters global configuration mode.
Step 2	switch(config)# snmp-server contact <i>sys-contact</i>	Configures the SNMP sysContact.
Step 3	switch(config)# callhome	Enters Smart Call Home configuration mode.
Step 4	switch(config-callhome)# email-contact <i>email-address</i>	Configures the e-mail address for the primary person responsible for the switch. The <i>email-address</i> can be up to 255 alphanumeric characters in an e-mail address format. Note You can use any valid e-mail address. The address cannot contain spaces.
Step 5	switch(config-callhome)# phone-contact <i>international-phone-number</i>	Configures the phone number in international phone number format for the primary person responsible for the device. The <i>international-phone-number</i> can be up to 17 alphanumeric characters and must be in international phone number format. Note The phone number cannot contain spaces. Use the plus (+) prefix before the number.
Step 6	switch(config-callhome)# streetaddress <i>address</i>	Configures the street address for the primary person responsible for the switch. The <i>address</i> can be up to 255 alphanumeric characters. Spaces are accepted.

	Command or Action	Purpose
Step 7	switch(config-callhome)# contract-id <i>contract-number</i>	(Optional) Configures the contract number for this switch from the service agreement. The <i>contract-number</i> can be up to 255 alphanumeric characters.
Step 8	switch(config-callhome)# customer-id <i>customer-number</i>	(Optional) Configures the customer number for this switch from the service agreement. The <i>customer-number</i> can be up to 255 alphanumeric characters.
Step 9	switch(config-callhome)# site-id <i>site-number</i>	(Optional) Configures the site number for this switch. The <i>site-number</i> can be up to 255 alphanumeric characters in free format.
Step 10	switch(config-callhome)# switch-priority <i>number</i>	(Optional) Configures the switch priority for this switch. The range is from 0 to 7, with 0 being the highest priority and 7 the lowest. The default is 7.
Step 11	switch# show callhome	(Optional) Displays a summary of the Smart Call Home configuration.
Step 12	switch(config)# copy running-config startup-config	(Optional) Saves the change persistently through reboots and restarts by copying the running configuration to the startup configuration.

The following example shows how to configure the contact information for Call Home:

```
switch# configuration terminal
switch(config)# snmp-server contact personname@companyname.com
switch(config)# callhome
switch(config-callhome)# email-contact personname@companyname.com
switch(config-callhome)# phone-contact +1-800-123-4567
switch(config-callhome)# street-address 123 Anystreet St., Anycity, Anywhere
```

What to Do Next

Create a destination profile.

Creating a Destination Profile

You must create a user-defined destination profile and configure the message format for that new destination profile.

Procedure

	Command or Action	Purpose
Step 1	switch# configure terminal	Enters global configuration mode.
Step 2	switch(config)# callhome	Enters Smart Call Home configuration mode.
Step 3	switch(config-callhome)# destination-profile {inspurTAC-1 { alert-group <i>group</i> email-addr <i>address</i> http <i>URL</i> transport-method { email http }} <i>profilename</i> { alert-group <i>group</i> email-addr <i>address</i> format { XML full-txt short-txt } http <i>URL</i> message-level <i>level</i> message-size <i>size</i> transport-method { email http }} full-txt-destination { alert-group <i>group</i> email-addr <i>address</i> http <i>URL</i> message-level <i>level</i> message-size <i>size</i> transport-method { email http }} short-txt-destination { alert-group <i>group</i> email-addr <i>address</i> http <i>URL</i> message-level <i>level</i> message-size <i>size</i> transport-method { email http }}}	Creates a new destination profile and sets the message format for the profile. The profile-name can be any alphanumeric string up to 31 characters.
Step 4	switch# show callhome destination-profile [<i>profile name</i>]	(Optional) Displays information about one or more destination profiles.
Step 5	switch(config)# copy running-config startup-config	(Optional) Saves the change persistently through reboots and restarts by copying the running configuration to the startup configuration.

The following example shows how to create a destination profile for Smart Call Home:

```
switch# configuration terminal
switch(config)# callhome
switch(config-callhome)# destination-profile Noc101 format full-text
```

Modifying a Destination Profile

You can modify the following attributes for a predefined or user-defined destination profile:

- Destination address—The actual address, pertinent to the transport mechanism, to which the alert should be sent.
- Message formatting—The message format used for sending the alert (full text, short text, or XML).
- Message level—The Call Home message severity level for this destination profile.
- Message size—The allowed length of a Call Home message sent to the e-mail addresses in this destination profile.



Note You cannot modify or delete the InspurTAC-1 destination profile.

Procedure

	Command or Action	Purpose
Step 1	switch# configure terminal	Enters global configuration mode.
Step 2	switch(config)# callhome	Enters Smart Call Home configuration mode.
Step 3	switch(config-callhome)# destination-profile { <i>name</i> full-txt-destination short-txt-destination } email-addr <i>address</i>	Configures an e-mail address for a user-defined or predefined destination profile. You can configure up to 50 e-mail addresses in a destination profile.
Step 4	destination-profile { <i>name</i> full-txt-destination short-txt-destination } message-level <i>number</i>	Configures the Smart Call Home message severity level for this destination profile. The switch sends only alerts that have a matching or higher Smart Call Home severity level to destinations in this profile. The range for the <i>number</i> is from 0 to 9, where 9 is the highest severity level.
Step 5	switch(config-callhome)# destination-profile { <i>name</i> full-txt-destination short-txt-destination } message-size <i>number</i>	Configures the maximum message size for this destination profile. The range is from 0 to 5000000 for full-txt-destination and the default is 2500000. The range is from 0 to 100000 for short-txt-destination and the default is 4000. The value is 5000000 for InspurTAC-1, which is not changeable.
Step 6	switch# show callhome destination-profile [<i>profile name</i>]	(Optional) Displays information about one or more destination profiles.
Step 7	switch(config)# copy running-config startup-config	(Optional) Saves the change persistently through reboots and restarts by copying the running configuration to the startup configuration.

The following example shows how to modify a destination profile for Smart Call Home:

```
switch# configuration terminal
switch(config)# callhome
switch(config-callhome)# destination-profile full-text-destination email-addr
person@example.com
switch(config-callhome)# destination-profile full-text-destination message-level 5
switch(config-callhome)# destination-profile full-text-destination message-size 10000
switch(config-callhome)#
```

What to Do Next

Associate an alert group with a destination profile.

Associating an Alert Group with a Destination Profile

Procedure

	Command or Action	Purpose
Step 1	switch# configure terminal	Enters global configuration mode.
Step 2	switch(config)# callhome	Enters Smart Call Home configuration mode.
Step 3	switch(config-callhome)# destination-profile <i>name</i> alert-group { All Inspur-TAC Configuration Diagnostic Environmental Inventory License Linecard-Hardware Supervisor-Hardware Syslog-group-port System Test }	Associates an alert group with this destination profile. Use the All keyword to associate all alert groups with the destination profile.
Step 4	switch# show callhome destination-profile [<i>profile name</i>]	(Optional) Displays information about one or more destination profiles.
Step 5	switch(config)# copy running-config startup-config	(Optional) Saves the change persistently through reboots and restarts by copying the running configuration to the startup configuration.

The following example shows how to associate all alert groups with the destination profile Noc101:

```
switch# configuration terminal
switch(config)# callhome
switch(config-callhome)# destination-profile Noc101 alert-group All
switch(config-callhome)#
```

What to Do Next

Optionally, you can add **show** commands to an alert group and configure the SMTP e-mail server.

Adding Show Commands to an Alert Group

You can assign a maximum of five user-defined **show** commands to an alert group.

Procedure

	Command or Action	Purpose
Step 1	switch# configure terminal	Enters global configuration mode.
Step 2	switch(config)# callhome	Enters Smart Call Home configuration mode.

	Command or Action	Purpose
Step 3	switch(config-callhome)# alert-group { Configuration Diagnostic Environmental Inventory License Linecard-Hardware Supervisor-Hardware Syslog-group-port System Test } user-def-cmd <i>show-cmd</i>	Adds the show command output to any Call Home messages sent for this alert group. Only valid show commands are accepted. Note You cannot add user-defined show commands to the InspurTAC-1 destination profile.
Step 4	switch# show callhome user-def-cmds	(Optional) Displays information about all user-defined show commands added to alert groups.
Step 5	switch(config)# copy running-config startup-config	(Optional) Saves the change persistently through reboots and restarts by copying the running configuration to the startup configuration.

The following example shows how to add the **show ip routing** command to the Inspur-TAC alert group:

```
switch# configuration terminal
switch(config)# callhome
switch(config-callhome)# alert-group Configuration user-def-cmd show ip routing
switch(config-callhome)#
```

What to Do Next

Configure Smart Call Home to connect to the SMTP e-mail server.

Configuring E-Mail Server Details

You must configure the SMTP server address for the Smart Call Home functionality to work. You can also configure the from and reply-to e-mail addresses.

Procedure

	Command or Action	Purpose
Step 1	switch# configure terminal	Enters global configuration mode.
Step 2	switch(config)# callhome	Enters Smart Call Home configuration mode.
Step 3	switch(config-callhome)# transport email smtp-server <i>ip-address</i> [port number] [use-vrf <i>vrf-name</i>]	Configures the SMTP server as either the domain name server (DNS) name, IPv4 address, or IPv6 address. The <i>number</i> range is from 1 to 65535. The default port number is 25. Optionally, you can configure the VRF instance to use when communicating with this SMTP server.

	Command or Action	Purpose
Step 4	switch(config-callhome)# transport email from <i>email-address</i>	(Optional) Configures the e-mail from field for Smart Call Home messages.
Step 5	switch(config-callhome)# transport email reply-to <i>email-address</i>	(Optional) Configures the e-mail reply-to field for Smart Call Home messages.
Step 6	switch# show callhome transport-email	(Optional) Displays information about the e-mail configuration for Smart Call Home.
Step 7	switch(config)# copy running-config startup-config	(Optional) Saves the change persistently through reboots and restarts by copying the running configuration to the startup configuration.

The following example shows how to configure the e-mail options for Smart Call Home messages:

```
switch# configuration terminal
switch(config)# callhome
switch(config-callhome)# transport email smtp-server 192.0.2.10 use-vrf Red
switch(config-callhome)# transport email from person@example.com
switch(config-callhome)# transport email reply-to person@example.com
switch(config-callhome)#
```

What to Do Next

Configure periodic inventory notifications.

Configuring Periodic Inventory Notifications

You can configure the switch to periodically send a message with an inventory of all software services currently enabled and running on the device with hardware inventory information. The switch generates two Smart Call Home notifications; periodic configuration messages and periodic inventory messages.

Procedure

	Command or Action	Purpose
Step 1	switch# configure terminal	Enters global configuration mode.
Step 2	switch(config)# callhome	Enters Smart Call Home configuration mode.
Step 3	switch(config-callhome)# periodic-inventory notification [interval days] [timeofday time]	Configures periodic inventory messages. The interval days range is from 1 to 30 days. The default is 7 days. The timeofday time is in HH:MM format.

	Command or Action	Purpose
Step 4	switch# show callhome	(Optional) Displays information about Smart Call Home.
Step 5	switch(config)# copy running-config startup-config	(Optional) Saves the change persistently through reboots and restarts by copying the running configuration to the startup configuration.

The following example shows how to configure the periodic inventory messages to generate every 20 days:

```
switch# configuration terminal
switch(config)# callhome
switch(config-callhome)# periodic-inventory notification interval 20
switch(config-callhome)#
```

What to Do Next

Disable duplicate message throttling.

Disabling Duplicate Message Throttling

You can limit the number of duplicate messages received for the same event. By default, the switch limits the number of duplicate messages received for the same event. If the number of duplicate messages sent exceeds 30 messages within a 2-hour time frame, the switch discards further messages for that alert type.

Procedure

	Command or Action	Purpose
Step 1	switch# configure terminal	Enters global configuration mode.
Step 2	switch(config)# callhome	Enters Smart Call Home configuration mode.
Step 3	switch(config-callhome) # no duplicate-message throttle	Disables duplicate message throttling for Smart Call Home. Duplicate message throttling is enabled by default.
Step 4	switch(config)# copy running-config startup-config	(Optional) Saves the change persistently through reboots and restarts by copying the running configuration to the startup configuration.

The following example shows how to disable duplicate message throttling:

```
switch# configuration terminal
switch(config)# callhome
switch(config-callhome)# no duplicate-message throttle
switch(config-callhome)#
```

What to Do Next

Enable Smart Call Home.

Enabling or Disabling Smart Call Home

Procedure

	Command or Action	Purpose
Step 1	switch# configure terminal	Enters global configuration mode.
Step 2	switch(config)# callhome	Enters Smart Call Home configuration mode.
Step 3	switch(config-callhome) # [no] enable	Enables or disables Smart Call Home. Smart Call Home is disabled by default.
Step 4	switch(config)# copy running-config startup-config	(Optional) Saves the change persistently through reboots and restarts by copying the running configuration to the startup configuration.

The following example shows how to enable Smart Call Home:

```
switch# configuration terminal
switch(config)# callhome
switch(config-callhome)# enable
switch(config-callhome)#
```

What to Do Next

Optionally, generate a test message.

Testing the Smart Call Home Configuration

Before You Begin

Verify that the message level for the destination profile is set to 2 or lower.

 **Important** Smart Call Home testing fails when the message level for the destination profile is set to 3 or higher.

Procedure

	Command or Action	Purpose
Step 1	switch# configure terminal	Enters global configuration mode.

	Command or Action	Purpose
Step 2	switch(config)# callhome	Enters Smart Call Home configuration mode.
Step 3	switch(config-callhome) # callhome send diagnostic	Sends the specified Smart Call Home message to all configured destinations.
Step 4	switch(config-callhome) # callhome test	Sends a test message to all configured destinations.
Step 5	switch(config)# copy running-config startup-config	(Optional) Saves the change persistently through reboots and restarts by copying the running configuration to the startup configuration.

The following example shows how to enable Smart Call Home:

```
switch# configuration terminal
switch(config)# callhome
switch(config-callhome)# callhome send diagnostic
switch(config-callhome)# callhome test
switch(config-callhome)#
```

Verifying the Smart Call Home Configuration

Use one of the following commands to verify the configuration:

Command	Purpose
show callhome	Displays the status for Smart Call Home.
show callhome destination-profile <i>name</i>	Displays one or more Smart Call Home destination profiles.
show callhome pending-diff	Displays the differences between the pending and running Smart Call Home configuration.
show callhome status	Displays the Smart Call Home status.
show callhome transport-email	Displays the e-mail configuration for Smart Call Home.
show callhome user-def-cmds	Displays CLI commands added to any alert groups.
show running-config [callhome callhome-all]	Displays the running configuration for Smart Call Home.
show startup-config callhome	Displays the startup configuration for Smart Call Home.
show tech-support callhome	Displays the technical support output for Smart Call Home.

Sample Syslog Alert Notification in Full-Text Format

This sample shows the full-text format for a syslog port alert-group notification:

```
source:MDS9000
Switch Priority:7
Device Id:WS-C6509@C@FG@07120011
Customer Id:Example.com
Contract Id:123
Site Id:San Jose
Server Id:WS-C6509@C@FG@07120011
Time of Event:2017-10-02T11:10:44
Message Name:SYSLOG_ALERT
Message Type:Syslog
Severity Level:2
System Name:10.76.100.177
Contact Name:User Name
Contact Email:person@example.com
Contact Phone:+1-408-555-1212
Street Address:#1234 Any Street, Any City, Any State, 12345
Event Description:2017 Oct 2 11:10:44 10.76.100.177 %PORT-5-IF_TRUNK_UP:
%$VLAN 1%$ Interface e2/5, vlan 1 is up
syslog_facility:PORT start
chassis information:
Affected Chassis:WS-C6509
Affected Chassis Serial Number:FG@07120011
Affected Chassis Hardware Version:0.104
Affected Chassis Software Version:3.1(1)
Affected Chassis Part No:73-8607-01
end chassis information:
```

Sample Syslog Alert Notification in XML Format

This sample shows the XML format for a syslog port alert-group notification:

```
From: example
Sent: Monday, October 2, 2017 7:20 AM
To: User (user)
Subject: System Notification From Router - syslog - 2017-10-2 14:19:55
GMT+00:00
<?xml version="1.0" encoding="UTF-8"?>
<soap-env:Envelope xmlns:soap-env="http://www.w3.org/2003/05/soap-
envelope"> <soap-env:Header>
<aml-session:Session xmlns:aml-session="http://www.example.com/2004/01/aml-
session" soap-env:mustUnderstand="true" soap-env:role=
"http://www.w3.org/2003/05/soap-envelope/role/next"> <aml-
session:To>http://tools.example.com/services/DCEService</aml-session:To> <aml-
session:Path> <aml-session:Via>http://www.example.com/appliance/uri</aml-
session:Via> </aml-session:Path> <aml-
session:From>http://www.example.com/appliance/uri</aml-session:From> <aml-
session:MessageId>M2:69000101:C9D9E20B</aml-session:MessageId> </aml-
session:Session>
</soap-env:Header>
<soap-env:Body>
<aml-block:Block xmlns:aml-block="http://www.example.com/2004/01/aml-block">
<aml-block:Header> <aml-
block:Type>http://www.example.com/2005/05/callhome/syslog</aml-block:Type>
<aml-block:CreationDate>2017-10-02 14:19:55 GMT+00:00</aml-block:CreationDate>
<aml-block:Builder>
<aml-block:Name>Cat6500</aml-block:Name>
<aml-block:Version>2.0</aml-
block:Version> </aml-block:Builder> <aml-
block:BlockGroup>
```

```

<aml-block:GroupId>G3:69000101:C9F9E20C</aml-
block:GroupId> <aml-block:Number>0</aml-block:Number>
<aml-block:IsLast>true</aml-block:IsLast> <aml-
block:IsPrimary>true</aml-block:IsPrimary> <aml-
block:WaitForPrimary>false</aml-block:WaitForPrimary>
</aml-block:BlockGroup> <aml-block:Severity>2</aml-
block:Severity> </aml-block:Header>

<aml-block:Content>
<ch:Call Home xmlns:ch="http://www.example.com/2005/05/callhome"
version="1.0"> <ch:EventTime>2017-10-02 14:19:55 GMT+00:00</ch:EventTime>
<ch:MessageDescription>03:29:29: %CLEAR-5-COUNTERS: Clear counter on all
interfaces by console</ch:MessageDescription>
<ch:Event>
<ch:Type>syslog</ch:Type>
<ch:SubType>
</ch:SubType>
<ch:Brand>Inspur</ch:Brand> <ch:Series>Catalyst 6500
Series Switches</ch:Series> </ch:Event>
<ch:CustomerData>
<ch:UserData>
<ch:Email>person@example.com</ch:Email>
</ch:UserData>
<ch:ContractData>
<ch:CustomerId>12345</ch:CustomerId>
<ch:SiteId>building 1</ch:SiteId>
<ch:ContractId>abcdefg12345</ch:ContractId>
<ch:DeviceId>WS-C6509@C@69000101</ch:DeviceId>
</ch:ContractData>
<ch:SystemInfo>
<ch:Name>Router</ch:Name>
<ch:Contact>
</ch:Contact>
<ch>ContactEmail>user@example.com</ch>ContactEmail>
<ch>ContactPhoneNumber>+1-408-555-1212</ch>ContactPhoneNumber>
<ch:StreetAddress>#1234 Any Street, Any City, Any State, 12345
</ch:StreetAddress>
</ch:SystemInfo>
</ch:CustomerData>
<ch:Device>
<rme:Chassis xmlns:rme="http://www.example.com/rme/4.0">
<rme:Model>WS-C6509</rme:Model>
<rme:HardwareVersion>1.0</rme:HardwareVersion>
<rme:SerialNumber>69000101</rme:SerialNumber>
<rme:AdditionalInformation>
<rme:AD name="PartNumber" value="73-3438-03 01" />
<rme:AD name="SoftwareVersion" value="4.0(20171002:012711)" />
</rme:AdditionalInformation>
</rme:Chassis>
</ch:Device> </ch:Call
Home> </aml-
block:Content> <aml-
block:Attachments>
<aml-block:Attachment type="inline"> <aml-
block:Name>show logging</aml-block:Name>
<aml-block:Data encoding="plain">
<![CDATA[Syslog logging: enabled (0 messages dropped, 0 messages rate-
limited, 0 flushes, 0 overruns, xml disabled, filtering disabled)
  Console logging: level debugging, 53 messages logged, xml disabled,
filtering disabled  Monitor logging: level debugging, 0 messages logged,
xml disabled,filtering disabled  Buffer logging: level debugging,
53 messages logged, xml disabled, filtering disabled  Exception
Logging: size (4096 bytes)  Count and timestamp loggingmessages: disabled
  Trap logging: level informational, 72 message lines logged
Log Buffer (8192 bytes):
00:00:54: curr is 0x20000
00:00:54: RP: Currently running ROMMON from F2 region
00:01:05: %SYS-5-CONFIG I: Configured from memory by console
00:01:09: %SYS-5-RESTART: System restarted -
s72033_rp Software (s72033_rp-ADVENTERPRISEK9_DBG-VM),
Experimental
Version 12.2(20171002:012711)
Compiled Mon 02-Oct-17 15:54 by xxx
]]>

```

Sample Syslog Alert Notification in XML Format

```

Firmware compiled 02-Oct-17 03:34 by integ Build [100]00:01:01: %PFREDUN-6-ACTIVE:
Initializing as ACTIVE processor for this switch00:01:01: %SYS-3-LOGGER_FLUSHED: System
was paused for 00:00:00 to ensure console debugging output.00:03:00: SP: SP: Currently
running ROMMON from F1 region00:03:07: %C6K_PLATFORM-SP-4-CONFREG_BREAK_ENABLED: The
default factory setting for config register is 0x2102.It is advisable
to retain 1 in 0x2102 as it prevents returning to ROMMON when break is issued.00:03:18:
%SYS-SP-5-RESTART: System restarted --Inspur INOS-CN Software, s72033_sp Software
(s72033_sp-ADVENTERPRISEK9_DBG-VM), Experimental Version 12.2(20171002:012711)Copyright
(c) 2017 by Inspur, Inc.
Compiled Mon 02-Oct-17 18:00 by xxx
00:03:18: %SYS-SP-6-BOOTTIME: Time taken to reboot after reload = 339 seconds
00:03:18: %OIR-SP-6-INSPS: Power supply inserted in slot 1
00:03:18: %C6KPWR-SP-4-PSOK: power supply 1 turned on.
00:03:18: %OIR-SP-6-INSPS: Power supply inserted in slot00:01:09: %SSH-5-ENABLED:
SSH 1.99 has been enabled
00:03:18: %C6KPWR-SP-4-PSOK: power supply 2 turned on.
00:03:18: %C6KPWR-SP-4-PSREDUNDANTMISMATCH: power supplies rated outputs do not match.
00:03:18: %C6KPWR-SP-4-PSREDUNDANTBOTHSUPPLY: in power-redundancy mode, system is
operating on both power supplies.
00:01:10: %CRYPTO-6-ISAKMP_ON_OFF: ISAKMP is OFF
00:01:10: %CRYPTO-6-ISAKMP_ON_OFF: ISAKMP is OFF
00:03:20: %C6KENV-SP-4-FANHIOUOUTPUT: Version 2 high-output fan-tray is in effect
00:03:22: %C6KPWR-SP-4-PSNOREDUNDANCY: Power supplies are not in full redundancy,
power usage exceeds lower capacity supply
00:03:26: %FABRIC-SP-5-FABRIC_MODULE_ACTIVE: The Switch Fabric Module in slot 6
became active.
00:03:28: %DIAG-SP-6-RUN_MINIMUM: Module 6: Running Minimal Diagnostics...
00:03:50: %DIAG-SP-6-DIAG_OK: Module 6: Passed Online Diagnostics
00:03:50: %OIR-SP-6-INSCARD: Card inserted in slot 6, interfaces are now online
00:03:51: %DIAG-SP-6-RUN_MINIMUM: Module 3: Running Minimal Diagnostics...
00:03:51: %DIAG-SP-6-RUN_MINIMUM: Module 7: Running Minimal Diagnostics...
00:03:51: %DIAG-SP-6-RUN_MINIMUM: Module 9: Running Minimal Diagnostics...
00:01:51: %MFIB_CONST_RP-6-REPLICATION_MODE_CHANGE: Replication Mode Change Detected.
Current system replication mode is Ingress
00:04:01: %DIAG-SP-6-DIAG_OK: Module 3: Passed Online Diagnostics
00:04:01: %OIR-SP-6-DOWNGRADE: Fabric capable module 3 not at an appropriate hardware
revision level, and can only run in flowthrough mode
00:04:02: %OIR-SP-6-INSCARD: Card inserted in slot 3, interfaces are now online
00:04:11: %DIAG-SP-6-DIAG_OK: Module 7: Passed Online Diagnostics
00:04:14: %OIR-SP-6-INSCARD: Card inserted in slot 7, interfaces are now online
00:04:35: %DIAG-SP-6-DIAG_OK: Module 9: Passed Online Diagnostics
00:04:37: %OIR-SP-6-INSCARD: Card inserted in slot 9, interfaces are now online
00:00:09: DaughterBoard (Distributed Forwarding Card 3)
Firmware compiled 02-Oct-17 03:34 by integ Build [100]
00:00:22: %SYS-DFC4-5-RESTART: System restarted --
Inspur DCOS Software, c6lc2 Software (c6lc2-SPDBG-VM), Experimental Version
4.0 (20171002:012711)
Compiled Mon 02-Oct-17 17:20 by xxx
00:00:23: DFC4: Currently running ROMMON from F2 region
00:00:25: %SYS-DFC2-5-RESTART: System restarted --
Inspur INOS-CN Software, c6slc Software (c6slc-SPDBG-VM), Experimental
Version 12.2 (20171002:012711)Copyright (c) 2017 by Inspur, Inc.
Compiled Mon 02-Oct-17 16:40 by username1
00:00:26: DFC2: Currently running ROMMON from F2 region
00:04:56: %DIAG-SP-6-RUN_MINIMUM: Module 4: Running Minimal Diagnostics...
00:00:09: DaughterBoard (Distributed Forwarding Card 3)
Firmware compiled 02-Oct-17 03:34 by integ Build [100]
slot id is 8
00:00:31: %FLASHFS_HES-DFC8-3-BADCARD: /bootflash:: The flash card seems to
be corrupted
00:00:31: %SYS-DFC8-5-RESTART: System restarted --
Inspur DCOS Software, c6lc2 Software (c6lc2-SPDBG-VM), Experimental Version
4.0 (20171002:012711)
Compiled Mon 02-Oct-17 17:20 by username1
00:00:31: DFC8: Currently running ROMMON from S (Gold) region
00:04:59: %DIAG-SP-6-RUN_MINIMUM: Module 2: Running Minimal Diagnostics...
00:05:12: %DIAG-SP-6-RUN_MINIMUM: Module 8: Running Minimal Diagnostics...
00:05:13: %DIAG-SP-6-RUN_MINIMUM: Module 1: Running Minimal Diagnostics...
00:00:24: %SYS-DFC1-5-RESTART: System restarted --
Inspur DCOS Software, c6slc Software (c6slc-SPDBG-VM), Experimental Version
4.0 (20171002:012711)
Compiled Mon 02-Oct-17 16:40 by username1
00:00:25: DFC1: Currently running ROMMON from F2 region

```

```
00:05:30: %DIAG-SP-6-DIAG_OK: Module 4: Passed Online Diagnostics
00:05:31: %SPAN-SP-6-SPAN_EGRESS_REPLICATION_MODE_CHANGE: Span Egress HW
Replication Mode Change Detected. Current replication mode for unused asic
session 0 is Centralized
00:05:31: %SPAN-SP-6-SPAN_EGRESS_REPLICATION_MODE_CHANGE: Span Egress HW
Replication Mode Change Detected. Current replication mode for unused asic
session 1 is Centralized
00:05:31: %OIR-SP-6-INSCARD: Card inserted in slot 4, interfaces are now online
00:06:02: %DIAG-SP-6-DIAG_OK: Module 1: Passed Online Diagnostics
00:06:03: %OIR-SP-6-INSCARD: Card inserted in slot 1, interfaces are now online
00:06:31: %DIAG-SP-6-DIAG_OK: Module 2: Passed Online Diagnostics
00:06:33: %OIR-SP-6-INSCARD: Card inserted in slot 2, interfaces are now online
00:04:30: %XDR-6-XDRIPCNOTIFY: Message not sent to slot 4/0 (4) because of
IPC error timeout. Disabling linecard. (Expected during linecard OIR)
00:06:59: %DIAG-SP-6-DIAG_OK: Module 8: Passed Online Diagnostics
00:06:59: %OIR-SP-6-DOWNGRADE_EARL: Module 8 DFC installed is not identical
to system PFC and will perform at current system operating mode.
00:07:06: %OIR-SP-6-INSCARD: Card inserted in slot 8, interfaces are now
online Router#]]>
</aml-block:Data> </aml-
block:Attachment> </aml-
block:Attachments> </aml-
block:Block> </soap-
env:Body> </soap-
env:Envelope>
```

Configuring Rollback

This chapter contains the following sections:

- [Information About Rollbacks, page 171](#)
- [Guidelines and Limitations for Rollbacks, page 171](#)
- [Creating a Checkpoint, page 172](#)
- [Implementing a Rollback, page 173](#)
- [Verifying the Rollback Configuration, page 173](#)

Information About Rollbacks

The rollback feature allows you to take a snapshot, or user checkpoint, of the Inspur INOS-CN configuration and then reapply that configuration to your switch at any point without having to reload the switch. A rollback allows any authorized administrator to apply this checkpoint configuration without requiring expert knowledge of the features configured in the checkpoint.

You can create a checkpoint copy of the current running configuration at any time. Inspur INOS-CN saves this checkpoint as an ASCII file which you can use to roll back the running configuration to the checkpoint configuration at a future time. You can create multiple checkpoints to save different versions of your running configuration.

When you roll back the running configuration, you can trigger an atomic rollback. An atomic rollback implements a rollback only if no errors occur.

Guidelines and Limitations for Rollbacks

A rollback has the following configuration guidelines and limitations:

- You can create up to ten checkpoint copies.
- You cannot apply the checkpoint file of one switch into another switch.
- Your checkpoint file names must be 75 characters or less.
- You cannot start a checkpoint filename with the word system.

- You can start a checkpoint filename with the word **auto**.
- You can name a checkpoint file **summary** or any abbreviation of the word **summary**.
- Only one user can perform a checkpoint, rollback, or copy the running configuration to the startup configuration at the same time.
- After you enter the **write erase** and **reload** command, checkpoints are deleted. You can use the clear checkpoint database command to clear out all checkpoint files.
- When checkpoints are created on bootflash, differences with the running-system configuration cannot be performed before performing the rollback, and the system reports “No Changes.”
- Checkpoints are local to a switch.
- Checkpoints that are created using the **checkpoint** and **checkpoint checkpoint_name** commands are present upon a switchover for all switches.
- A rollback to files on bootflash is supported only on files that are created using the **checkpoint checkpoint_name** command and not on any other type of ASCII file.
- Checkpoint names must be unique. You cannot overwrite previously saved checkpoints with the same name.

Creating a Checkpoint

You can create up to ten checkpoints of your configuration per switch.

Procedure

	Command or Action	Purpose
Step 1	<pre>switch# checkpoint { <i>[cp-name]</i> [description <i>descr</i>] [file <i>file-name</i>]</pre> <p>Example:</p> <pre>switch# checkpoint stable</pre>	<p>Creates a checkpoint of the running configuration to either a user checkpoint name or a file. The checkpoint name can be any alphanumeric string up to 80 characters but cannot contain spaces. If you do not provide a name, Inspur INOS-CN sets the checkpoint name to user-checkpoint-<number> where number is from 1 to 10.</p> <p>The description can contain up to 80 alphanumeric characters, including spaces.</p>
Step 2	<pre>switch# no checkpoint<i>cp-name</i></pre> <p>Example:</p> <pre>switch# no checkpoint stable</pre>	<p>(Optional)</p> <p>You can use the no form of the checkpoint command to remove a checkpoint name.</p> <p>Use the delete command to remove a checkpoint file.</p>
Step 3	<pre>switch# show checkpoint<i>cp-name</i></pre> <p>Example:</p> <pre>[all] switch# show checkpoint stable</pre>	<p>(Optional) Displays the contents of the checkpoint name.</p>

Implementing a Rollback

You can implement a rollback to a checkpoint name or file. Before you implement a rollback, you can view the differences between source and destination checkpoints that reference current or saved configurations.



Note If you make a configuration change during an atomic rollback, the rollback will fail.

Procedure

	Command or Action	Purpose
Step 1	show diff rollback-patch { checkpoint <i>src-cp-name</i> running-config startup-config file <i>source-file</i> } { checkpoint <i>dest-cp-name</i> running-config startup-config file <i>dest-file</i> } Example: <pre>switch# show diff rollback-patch checkpoint stable running-config</pre>	Displays the differences between the source and destination checkpoint selections.
Step 2	rollback running-config { checkpoint <i>cp-name</i> file <i>cp-file</i> } atomic Example: <pre>switch# rollback running-config checkpoint stable</pre>	Creates an atomic rollback to the specified checkpoint name or file if no errors occur.

The following example shows how to create a checkpoint file and then implement an atomic rollback to a user checkpoint name:

```
switch# checkpoint stable
switch# rollback running-config checkpoint stable atomic
```

Verifying the Rollback Configuration

Use the following commands to verify the rollback configuration:

Command	Purpose
show checkpoint <i>name</i> [all]	Displays the contents of the checkpoint name.
show checkpoint all [user system]	Displays the contents of all checkpoints in the current switch. You can limit the displayed checkpoints to user or system-generated checkpoints.

Command	Purpose
show checkpoint summary [user system]	Displays a list of all checkpoints in the current switch. You can limit the displayed checkpoints to user or system-generated checkpoints.
show diff rollback-patch { checkpoint <i>src-cp-name</i> running-config startup-config file <i>source-file</i> } { checkpoint <i>dest-cp-name</i> running-config startup-config file <i>dest-file</i> }	Displays the differences between the source and destination checkpoint selections.
show rollback log [exec verify]	Displays the contents of the rollback log.



Note Use the **clear checkpoint database** command to delete all checkpoint files.

Configuring DNS

This chapter contains the following sections:

- [Information About DNS Client](#) , page 175
- [Prerequisites for DNS Clients](#), page 176
- [Licensing Requirements for DNS Clients](#), page 176
- [Default Settings for DNS Clients](#), page 176
- [Configuring the DNS Source Interface](#), page 177
- [Configuring DNS Clients](#), page 177

Information About DNS Client

If your network devices require connectivity with devices in networks for which you do not control name assignment, you can assign device names that uniquely identify your devices within the entire internetwork using the domain name server (DNS). DNS uses a hierarchical scheme for establishing hostnames for network nodes, which allows local control of the segments of the network through a client-server scheme. The DNS system can locate a network device by translating the hostname of the device into its associated IP address.

On the Internet, a domain is a portion of the naming hierarchy tree that refers to general groupings of networks based on the organization type or geography. Domain names are pieced together with periods (.) as the delimiting characters. For example, Inspur is a commercial organization that the Internet identifies by a com domain, so its domain name is `inspur.com`. A specific hostname in this domain, the File Transfer Protocol (FTP) system, for example, is identified as `ftp.inspur.com`.

Name Servers

Name servers keep track of domain names and know the parts of the domain tree for which they have complete information. A name server may also store information about other parts of the domain tree. To map domain names to IP addresses in Inspur INOS-CN, you must first identify the hostnames, then specify a name server, and enable the DNS service.

Inspur INOS-CN allows you to statically map IP addresses to domain names. You can also configure Inspur INOS-CN to use one or more domain name servers to find an IP address for a hostname.

DNS Operation

A name server handles client-issued queries to the DNS server for locally defined hosts within a particular zone as follows:

- An authoritative name server responds to DNS user queries for a domain name that is under its zone of authority by using the permanent and cached entries in its own host table. If the query is for a domain name that is under its zone of authority but for which it does not have any configuration information, the authoritative name server replies that no such information exists.
- A name server that is not configured as the authoritative name server responds to DNS user queries by using information that it has cached from previously received query responses. If no router is configured as the authoritative name server for a zone, queries to the DNS server for locally defined hosts receive nonauthoritative responses.

Name servers answer DNS queries (forward incoming DNS queries or resolve internally generated DNS queries) according to the forwarding and lookup parameters configured for the specific domain.

High Availability

Inspur INOS-CN supports stateless restarts for the DNS client. After a reboot or supervisor switchover, Inspur INOS-CN applies the running configuration.

Prerequisites for DNS Clients

The DNS client has the following prerequisites:

- You must have a DNS name server on your network.

Licensing Requirements for DNS Clients

The following table shows the licensing requirements for this feature:

Product	Licence Requirement
Inspur INOS-CN	DNS requires no license. Any feature not included in a license package is bundled with the Inspur INOS-CN image and is provided at no extra charge to you.

Default Settings for DNS Clients

The following table shows the default settings for DNS client parameters.

Parameter	Default
DNS client	Enabled

Configuring the DNS Source Interface

You can configure DNS to use a specific interface.

Procedure

	Command or Action	Purpose
Step 1	switch# configure terminal	Enters global configuration mode.
Step 2	switch(config)# ip dns source-interface <i>type slot/port</i>	Configures the source interface for all DNS packets. The following list contains the valid values for <i>interface</i> . <ul style="list-style-type: none"> • ethernet • loopback • mgmt • port-channel • vlan <p>Note When you, configure the source interface for DNS, SCP copy operations initiated from the server fail. To perform an SCP copy operation from the server, remove the DNS source interface configuration.</p>
Step 3	switch(config)# show ip dns source-interface	Displays the configured DNS source interface.

This example shows how to configure the DNS source interface:

```
switch(config)# configure terminal
Enter configuration commands, one per line. End with CNTL/Z.
switch(config)# ip dns source-interface ethernet 1/8
switch(config)# show ip dns source-interface
VRF Name                Interface
default                  Ethernet1/8
```

Configuring DNS Clients

You can configure the DNS client to use a DNS server on your network.

Before You Begin

- Ensure that you have a domain name server on your network.

Procedure

	Command or Action	Purpose
Step 1	switch# configuration terminal	Enters global configuration mode.
Step 2	switch(config)# vrf context managment	Specifies a configurable virtual and routing (VRF) name.
Step 3	switch(config)# {ip ipv6} host name ipv/ipv6 address1 [ip/ipv6 address2... ip/ipv6 address6]	Defines up to six static hostname-to-address mappings in the host name cache.
Step 4	switch(config)# ip domain name name [use-vrf vrf-name]	(Optional) Defines the default domain name server that Inspur INOS-CN uses to complete unqualified hostnames. You can optionally define a VRF that Inspur INOS-CN uses to resolve this domain name server if it cannot be resolved in the VRF that you configured this domain name under. Inspur INOS-CN appends the default domain name to any host name that does not contain a complete domain name before starting a domain-name lookup.
Step 5	switch(config)# ip domain-list name [use-vrf vrf-name]	(Optional) Defines additional domain name servers that Inspur INOS-CN can use to complete unqualified hostnames. You can optionally define a VRF that Inspur INOS-CN uses to resolve this domain name server if it cannot be resolved in the VRF that you configured this domain name under. Inspur INOS-CN uses each entry in the domain list to append that domain name to any hostname that does not contain a complete domain name before starting a domain-name lookup. Inspur INOS-CN continues this for each entry in the domain list until it finds a match.
Step 6	switch(config)# ip name-server ip/ipv6 server-address1 [ip/ipv6 server-address2... ip/ipv6 server-address6] [use-vrf vrf-name]	(Optional) Defines up to six name servers. The address can be either an IPv4 address or an IPv6 address. You can optionally define a VRF that Inspur INOS-CN uses to reach this name server if it cannot be reached in the VRF that you configured this name server under.
Step 7	switch(config)# ip domain-lookup	(Optional) Enables DNS-based address translation. This feature is enabled by default.
Step 8	switch(config)# show hosts	(Optional) Displays information about DNS.
Step 9	switch(config)# exit	Exits configuration mode and returns to EXEC mode.

	Command or Action	Purpose
Step 10	switch# copy running-config startup-config	(Optional) Copies the running configuration to the startup configuration.

The following example shows how to configure a default domain name and enable DNS lookup:

```
switch# config t
switch(config)# vrf context management
switch(config)# ip domain-name mycompany.com
switch(config)# ip name-server 172.68.0.10
switch(config)# ip domain-lookup
```

Configuring SNMP

This chapter contains the following sections:

- [Information About SNMP, page 181](#)
- [Licensing Requirements for SNMP, page 185](#)
- [Guidelines and Limitations for SNMP, page 185](#)
- [Default SNMP Settings, page 186](#)
- [Configuring SNMP, page 186](#)
- [Configuring the SNMP Local Engine ID, page 197](#)
- [Disabling SNMP, page 198](#)
- [Verifying the SNMP Configuration, page 199](#)

Information About SNMP

The Simple Network Management Protocol (SNMP) is an application-layer protocol that provides a message format for communication between SNMP managers and agents. SNMP provides a standardized framework and a common language used for the monitoring and management of devices in a network.

SNMP Functional Overview

The SNMP framework consists of three parts:

- An SNMP manager—The system used to control and monitor the activities of network devices using SNMP.
- An SNMP agent—The software component within the managed device that maintains the data for the device and reports these data, as needed, to managing systems. The Inspur CN6000 device supports the agent. To enable the SNMP agent, you must define the relationship between the manager and the agent.

The Inspur CN6000 device supports SNMPv1, SNMPv2c, and SNMPv3. Both SNMPv1 and SNMPv2c use a community-based form of security.

SNMP is defined in RFC 3410 (<http://tools.ietf.org/html/rfc3410>), RFC 3411 (<http://tools.ietf.org/html/rfc3411>), RFC 3412 (<http://tools.ietf.org/html/rfc3412>), RFC 3413 (<http://tools.ietf.org/html/rfc3413>), RFC 3414 (<http://tools.ietf.org/html/rfc3414>), RFC 3415 (<http://tools.ietf.org/html/rfc3415>), RFC 3416 (<http://tools.ietf.org/html/rfc3416>), RFC 3417 (<http://tools.ietf.org/html/rfc3417>), RFC 3418 (<http://tools.ietf.org/html/rfc3418>), and RFC 3584 (<http://tools.ietf.org/html/rfc3584>).

SNMP Notifications

A key feature of SNMP is the ability to generate notifications from an SNMP agent. These notifications do not require that requests be sent from the SNMP manager. Notifications can indicate improper user authentication, restarts, the closing of a connection, loss of connection to a neighbor router, or other significant events.

Inspur INOS-CN generates SNMP notifications as either traps or informs. A trap is an asynchronous, unacknowledged message sent from the agent to the SNMP managers listed in the host receiver table. Informs are asynchronous messages sent from the SNMP agent to the SNMP manager which the manager must acknowledge receipt of.

Traps are less reliable than informs because the SNMP manager does not send any acknowledgment when it receives a trap. The switch cannot determine if the trap was received. An SNMP manager that receives an inform request acknowledges the message with an SNMP response protocol data unit (PDU). If the Inspur CN6000 device never receives a response, it can send the inform request again.

You can configure Inspur INOS-CN to send notifications to multiple host receivers.

SNMPv3

SNMPv3 provides secure access to devices by a combination of authenticating and encrypting frames over the network. The security features provided in SNMPv3 are the following:

- Message integrity—Ensures that a packet has not been tampered with in-transit.
- Authentication—Determines the message is from a valid source.
- Encryption—Scrambles the packet contents to prevent it from being seen by unauthorized sources.

SNMPv3 provides for both security models and security levels. A security model is an authentication strategy that is set up for a user and the role in which the user resides. A security level is the permitted level of security within a security model. A combination of a security model and a security level determines which security mechanism is employed when handling an SNMP packet.

Security Models and Levels for SNMPv1, v2, and v3

The security level determines if an SNMP message needs to be protected from disclosure and if the message needs to be authenticated. The various security levels that exist within a security model are as follows:

- noAuthNoPriv—Security level that does not provide authentication or encryption. This level is not supported for SNMPv3.
- authNoPriv—Security level that provides authentication but does not provide encryption.
- authPriv—Security level that provides both authentication and encryption.

Three security models are available: SNMPv1, SNMPv2c, and SNMPv3. The security model combined with the security level determine the security mechanism applied when the SNMP message is processed.

Table 27: SNMP Security Models and Levels

Model	Level	Authentication	Encryption	What Happens
v1	noAuthNoPriv	Community string	No	Uses a community string match for authentication.
v2c	noAuthNoPriv	Community string	No	Uses a community string match for authentication.
v3	authNoPriv	HMAC-MD5 or HMAC-SHA	No	Provides authentication based on the Hash-Based Message Authentication Code (HMAC) Message Digest 5 (MD5) algorithm or the HMAC Secure Hash Algorithm (SHA).
v3	authPriv	HMAC-MD5 or HMAC-SHA	DES	Provides authentication based on the HMAC-MD5 or HMAC-SHA algorithms. Provides Data Encryption Standard (DES) 56-bit encryption in addition to authentication based on the Cipher Block Chaining (CBC) DES (DES-56) standard.

User-Based Security Model

SNMPv3 User-Based Security Model (USM) refers to SNMP message-level security and offers the following services:

- Message integrity—Ensures that messages have not been altered or destroyed in an unauthorized manner and that data sequences have not been altered to an extent greater than can occur nonmaliciously.
- Message origin authentication—Confirms that the claimed identity of the user who received the data was originated.
- Message confidentiality—Ensures that information is not made available or disclosed to unauthorized individuals, entities, or processes.

SNMPv3 authorizes management operations only by configured users and encrypts SNMP messages.

Inspur INOS-CN uses two authentication protocols for SNMPv3:

- HMAC-MD5-96 authentication protocol
- HMAC-SHA-96 authentication protocol

Inspur INOS-CN uses Advanced Encryption Standard (AES) as one of the privacy protocols for SNMPv3 message encryption and conforms with RFC 3826.

The **priv** option offers a choice of DES or 128-bit AES encryption for SNMP security encryption. The **priv** option and the **aes-128** token indicates that this privacy password is for generating a 128-bit AES key #. The AES priv password can have a minimum of eight characters. If the passphrases are specified in clear text, you can specify a maximum of 64 characters. If you use the localized key, you can specify a maximum of 130 characters.



Note

For an SNMPv3 operation using the external AAA server, you must use AES for the privacy protocol in user configuration on the external AAA server.

CLI and SNMP User Synchronization

SNMPv3 user management can be centralized at the Access Authentication and Accounting (AAA) server level. This centralized user management allows the SNMP agent in Inspur INOS-CN to leverage the user authentication service of the AAA server. Once user authentication is verified, the SNMP PDUs are processed further. Additionally, the AAA server is also used to store user group names. SNMP uses the group names to apply the access/role policy that is locally available in the switch.

Any configuration changes made to the user group, role, or password results in database synchronization for both SNMP and AAA.

Inspur INOS-CN synchronizes user configuration in the following ways:

- The **auth** passphrase specified in the **snmp-server user** command becomes the password for the CLI user.
- The password specified in the **username** command becomes the **auth** and **priv** passphrases for the SNMP user.

- If you create or delete a user using either SNMP or the CLI, the user is created or deleted for both SNMP and the CLI.
- User-role mapping changes are synchronized in SNMP and the CLI.
- Role changes (deletions or modifications from the CLI) are synchronized to SNMP.



Note When you configure passphrase/password in localized key/encrypted format, Inspur INOS-CN does not synchronize the user information (passwords, rules, etc.).

Group-Based SNMP Access



Note Because a group is a standard SNMP term used industry-wide, roles are referred to as groups in this SNMP section.

SNMP access rights are organized by groups. Each group in SNMP is similar to a role through the CLI. Each group is defined with three accesses: read access, write access, and notification access. Each access can be enabled or disabled within each group.

You can begin communicating with the agent once your username is created, your roles are set up by your administrator, and you are added to the roles.

Licensing Requirements for SNMP

This feature does not require a license. Any feature not included in a license package is bundled with the Inspur INOS-CN image and is provided at no extra charge to you.

Guidelines and Limitations for SNMP

SNMP has the following configuration guidelines and limitations:

- Access control list (ACLs) can be applied only to local SNMPv3 users configured on the switch. ACLs cannot be applied to remote SNMPv3 users stored on Authentication, Authorization, and Accounting (AAA) servers.
- Inspur INOS-CN does not support the SNMPv3 noAuthNoPriv security level.

Default SNMP Settings

Table 28: Default SNMP Parameters

Parameters	Default
license notifications	Enabled
linkUp/Down notification type	ietf-extended

Configuring SNMP

Configuring the SNMP Source Interface

You can configure SNMP to use a specific interface.

Procedure

	Command or Action	Purpose
Step 1	switch# configure terminal	Enters global configuration mode.
Step 2	switch(config)# snmp-server source-interface {inform trap} type slot/port	Configures the source interface for all SNMP packets. The following list contains the valid values for <i>interface</i> . <ul style="list-style-type: none"> • ethernet • loopback • mgmt • port-channel • vlan
Step 3	switch(config)# show snmp source-interface	Displays the configured SNMP source interface.

This example shows how to configure the SNMP source interface:

```
switch(config)# configure terminal
Enter configuration commands, one per line. End with CNTL/Z.
switch(config)# snmp-server source-interface inform ethernet 1/10
switch(config)# snmp-server source-interface trap ethernet 1/10
switch(config)# show snmp source-interface
-----
Notification                               source-interface
-----
```

```

trap                               Ethernet1/10
inform                             Ethernet1/10
-----

```

Configuring SNMP Users



Procedure

	Command or Action	Purpose
Step 1	configure terminal Example: switch# configure terminal switch(config)#	Enters global configuration mode.
Step 2	switch(config)# snmp-server user name [auth {md5 sha} passphrase [auto] [priv [aes-128] passphrase] [engineID id] [localizedkey]] Example: switch(config)# snmp-server user Admin auth sha abcd1234 priv abcdefgh	Configures an SNMP user with authentication and privacy parameters. The passphrase can be any case-sensitive, alphanumeric string up to 64 characters. If you use the localizedkey keyword, the passphrase can be any case-sensitive, alphanumeric string up to 130 characters. The engineID format is a 12-digit, colon-separated decimal number.
Step 3	switch# show snmp user Example: switch(config) # show snmp user	(Optional) Displays information about one or more SNMP users.
Step 4	copy running-config startup-config Example: switch(config)# copy running-config startup-config	(Optional) Saves the change persistently through reboots and restarts by copying the running configuration to the startup configuration.

The following example shows how to configure an SNMP user:

```

switch# config t
Enter configuration commands, one per line. End with CNTL/Z.
switch(config)# snmp-server user Admin auth sha abcd1234 priv abcdefgh

```

Enforcing SNMP Message Encryption

You can configure SNMP to require authentication or encryption for incoming requests. By default, the SNMP agent accepts SNMPv3 messages without authentication and encryption. When you enforce privacy, Inspur INOS-CN responds with an authorization error for any SNMPv3 PDU request that uses a security level parameter of either **noAuthNoPriv** or **authNoPriv**.

Use the following command in global configuration mode to enforce SNMP message encryption for a specific user:

Command	Purpose
switch(config)# snmp-server user <i>name</i> enforcePriv	Enforces SNMP message encryption for this user.

Use the following command in global configuration mode to enforce SNMP message encryption for all users:

Command	Purpose
switch(config)# snmp-server globalEnforcePriv	Enforces SNMP message encryption for all users.

Assigning SNMPv3 Users to Multiple Roles

After you configure an SNMP user, you can assign multiple roles for the user.

Note

Only users who belong to a network-admin role can assign roles to other users.

Command	Purpose
switch(config)# snmp-server user <i>name</i> <i>group</i>	Associates this SNMP user with the configured user role.

Creating SNMP Communities

You can create SNMP communities for SNMPv1 or SNMPv2c.

Command	Purpose
switch(config)# snmp-server community <i>name</i> <i>group</i> { ro rw }	Creates an SNMP community string.

Filtering SNMP Requests

You can assign an access list (ACL) to a community to filter incoming SNMP requests. If the assigned ACL allows the incoming request packet, SNMP processes the request. If the ACL denies the request, SNMP drops the request and sends a system message.

Create the ACL with the following parameters:

- Source IP address
- Destination IP address
- Source port
- Destination port
- Protocol (UDP or TCP)

The ACL applies to both IPv4 and IPv6 over UDP and TCP. After creating the ACL, assign the ACL to the SNMP community.



Tip For more information about creating ACLs, see the *Inspur CN6000 INOS-CN Security Configuration Guide*.

Use the following command in global configuration mode to assign an ACL to a community to filter SNMP requests:

Command	Purpose
<pre>switch(config)# snmp-server community <i>community name</i> use-acl <i>acl-name</i></pre> <p>Example:</p> <pre>switch(config)# snmp-server community public use-acl my_acl_for_public</pre>	Assigns an IPv4 or IPv6 ACL to an SNMP community to filter SNMP requests.

Configuring SNMP Notification Receivers

You can configure Inspur INOS-CN to generate SNMP notifications to multiple host receivers.

You can configure a host receiver for SNMPv1 traps in a global configuration mode.

Command	Purpose
<pre>switch(config)# snmp-server host <i>ip-address</i> traps version 1 <i>community</i> [<i>udp_port number</i>]</pre>	Configures a host receiver for SNMPv1 traps. The <i>ip-address</i> can be an IPv4 or IPv6 address. The <i>community</i> can be any alphanumeric string up to 255 characters. The UDP port number range is from 0 to 65535.

You can configure a host receiver for SNMPv2c traps or informs in a global configuration mode.

Command	Purpose
switch(config)# snmp-server host <i>ip-address</i> { traps informs } version 2c <i>community</i> [udp_port <i>number</i>]	Configures a host receiver for SNMPv2c traps or informs. The <i>ip-address</i> can be an IPv4 or IPv6 address. The <i>community</i> can be any alphanumeric string up to 255 characters. The UDP port number range is from 0 to 65535.

You can configure a host receiver for SNMPv3 traps or informs in a global configuration mode.

Command	Purpose
switch(config)# snmp-server host <i>ip-address</i> { traps informs } version 3 { auth noauth priv } <i>username</i> [udp_port <i>number</i>]	Configures a host receiver for SNMPv2c traps or informs. The <i>ip-address</i> can be an IPv4 or IPv6 address. The <i>username</i> can be any alphanumeric string up to 255 characters. The UDP port number range is from 0 to 65535.

**Note**

The SNMP manager must know the user credentials (authKey/PrivKey) based on the SNMP engineID of the Inspur CN6000 device to authenticate and decrypt the SNMPv3 messages.

The following example shows how to configure a host receiver for an SNMPv1 trap:

```
switch(config)# snmp-server host 192.0.2.1 traps version 1 public
```

The following example shows how to configure a host receiver for an SNMPv2 inform:

```
switch(config)# snmp-server host 192.0.2.1 informs version 2c public
```

The following example shows how to configure a host receiver for an SNMPv3 inform:

```
switch(config)# snmp-server host 192.0.2.1 informs version 3 auth NMS
```

Configuring SNMP Notification Receivers with VRFs

You can configure Inspur INOS-CN to use a configured VRF to reach the host receiver.

**Note**

You must configure the host before configuring the VRF reachability or filtering options.

Procedure

	Command or Action	Purpose
Step 1	switch# configure terminal	Enters global configuration mode.
Step 2	switch# snmp-server host <i>ip-address use-vrf vrf_name</i> [udp_port number]	Configures SNMP to use the selected VRF to communicate with the host receiver. The IP address can be an IPv4 or IPv6 address. The VRF name can be any alphanumeric string up to 255 characters. The UDP port number range is from 0 to 65535. This command adds an entry into the ExtSnmptargetVrfTable of the ICNT-SNMP-TARGET-EXT-MB.
Step 3	switch(config)# copy running-config startup-config	(Optional) Saves the change persistently through reboots and restarts by copying the running configuration to the startup configuration.

The following example shows how to configure the SNMP server host with IP address 192.0.2.1 to use the VRF named "Blue:"

```
switch# configuration terminal
switch(config)# snmp-server host 192.0.2.1 use-vrf Blue
switch(config)# copy running-config startup-config
```

Filtering SNMP Notifications Based on a VRF

You can configure Inspur INOS-CN filter notifications based on the VRF in which the notification occurred.

Procedure

	Command or Action	Purpose
Step 1	switch# configure terminal	Enters global configuration mode.
Step 2	switch(config)# snmp-server host <i>ip-address filter-vrf vrf_name</i> [udp_port number]	Filters notifications to the notification host receiver based on the configured VRF. The IP address can be an IPv4 or IPv6 address. The VRF name can be any alphanumeric string up to 255 characters. The UDP port number range is from 0 to 65535. This command adds an entry into the ExtSnmptargetVrfTable of the ICNT-SNMP-TARGET-EXT-MB.
Step 3	switch(config)# copy running-config startup-config	(Optional) Saves the change persistently through reboots and restarts by copying the running configuration to the startup configuration.

The following example shows how to configure filtering of SNMP notifications based on a VRF:

```
switch# configuration terminal
switch(config)# snmp-server host 192.0.2.1 filter-vrf Red
switch(config)# copy running-config startup-config
```

Configuring SNMP for Inband Access

You can configure SNMP for inband access using the following:

- Using SNMP v2 without context—You can use a community that is mapped to a context. In this case, the SNMP client does not need to know about the context.
- Using SNMP v2 with context—The SNMP client needs to specify the context by specifying a community; for example, <community>@<context>.
- Using SNMP v3—You can specify the context.

Procedure

	Command or Action	Purpose
Step 1	switch# configuration terminal	Enters global configuration mode.
Step 2	switch(config)# snmp-server context <i>context-name vrf vrf-name</i>	Maps an SNMP context to the management VRF or default VRF. Custom VRFs are not supported. The names can be any alphanumeric string up to 32 characters.
Step 3	switch(config)# snmp-server community <i>community-name</i> group <i>group-name</i>	Maps an SNMPv2c community to an SNMP context and identifies the group to which the community belongs. The names can be any alphanumeric string up to 32 characters.
Step 4	switch(config)# snmp-server mib community-map <i>community-name</i> context <i>context-name</i>	Maps an SNMPv2c community to an SNMP context. The names can be any alphanumeric string up to 32 characters.

The following SNMPv2 example shows how to map a community named snmpdefault to a context:

```
switch# config t
Enter configuration commands, one per line. End with CNTL/Z.
switch(config)# snmp-server context def vrf default
switch(config)# snmp-server community snmpdefault group network-admin
switch(config)# snmp-server mib community-map snmpdefault context def
switch(config)#
```

The following SNMPv2 example shows how to configure and inband access to the community comm which is not mapped:

```
switch# config t
Enter configuration commands, one per line. End with CNTL/Z.
switch(config)# snmp-server context def vrf default
switch(config)# snmp-server community comm group network-admin
switch(config)#
```

The following SNMPv3 example shows how to use a v3 username and password:

```
switch# config t
Enter configuration commands, one per line. End with CNTL/Z.
switch(config)# snmp-server context def vrf default
switch(config)#
```

Enabling SNMP Notifications

You can enable or disable notifications. If you do not specify a notification name, Inspur INOS-CN enables all notifications.



Note The `snmp-server enable traps` CLI command enables both traps and informs, depending on the configured notification host receivers.

The following table lists the CLI commands that enable the notifications for Inspur INOS-CN MIBs.

Table 29: Enabling SNMP Notifications

MIB	Related Commands
All notifications	<code>snmp-server enable traps</code>
ICNT-ERR-DISABLE-MIB	<code>snmp-server enable traps show interface status</code>
Q-BRIDGE-MIB	<code>snmp-server enable traps show mac address-table</code>
ICNT-SWITCH-QOS-MIB	<code>snmp-server enable traps show hardware internal buffer info pkt-stats</code>
BRIDGE-MIB	<code>snmp-server enable traps bridge newroot</code> <code>snmp-server enable traps bridge topologychange</code>
ICNT-AAA-SERVER-MIB	<code>snmp-server enable traps aaa</code>
ENTITY-MIB, ICNT-ENTITY-FRU-CONTROL-MIB, ICNT-ENTITY-SENSOR-MIB	<code>snmp-server enable traps entity</code> <code>snmp-server enable traps entity fru</code>
ICNT-LICENSE-MGR-MIB	<code>snmp-server enable traps license</code>
IF-MIB	<code>snmp-server enable traps link</code>
ICNT-PSM-MIB	<code>snmp-server enable traps port-security</code>
SNMPv2-MIB	<code>snmp-server enable traps snmp</code> <code>snmp-server enable traps snmp authentication</code>
ICNT-FCC-MIB	<code>snmp-server enable traps fcc</code>

MIB	Related Commands
ICNT-DM-MIB	<code>snmp-server enable traps fcdomain</code>
ICNT-NS-MIB	<code>snmp-server enable traps fcns</code>
ICNT-FCS-MIB	<code>snmp-server enable traps fcs discovery-complete</code> <code>snmp-server enable traps fcs request-reject</code>
ICNT-FDMI-MIB	<code>snmp-server enable traps fdmi</code>
ICNT-FSPF-MIB	<code>snmp-server enable traps fspf</code>
ICNT-PSM-MIB	<code>snmp-server enable traps port-security</code>
ICNT-RSCN-MIB	<code>snmp-server enable traps rscn</code> <code>snmp-server enable traps rscn els</code> <code>snmp-server enable traps rscn ils</code>
ICNT-ZS-MIB	<code>snmp-server enable traps zone</code> <code>snmp-server enable traps zone default-zone-behavior-change</code> <code>snmp-server enable traps zone enhanced-zone-db-change</code> <code>snmp-server enable traps zone merge-failure</code> <code>snmp-server enable traps zone merge-success</code> <code>snmp-server enable traps zone request-reject</code> <code>snmp-server enable traps zone unsupp-mem</code>
ICNT-CONFIG-MAN-MIB Note Supports no MIB objects except the following notification: ccmCLIRunningConfigChanged	<code>snmp-server enable traps config</code>



Note The license notifications are enabled by default.

To enable the specified notification in the global configuration mode, perform one of the following tasks:

Command	Purpose
<code>switch(config)# snmp-server enable traps</code>	Enables all SNMP notifications.
<code>switch(config)# snmp-server enable traps aaa [server-state-change]</code>	Enables the AAA SNMP notifications.

Command	Purpose
switch(config)# snmp-server enable traps entity [fru]	Enables the ENTITY-MIB SNMP notifications.
switch(config)# snmp-server enable traps license	Enables the license SNMP notification.
switch(config)# snmp-server enable traps port-security	Enables the port security SNMP notifications.
switch(config)# snmp-server enable traps snmp [authentication]	Enables the SNMP agent notifications.

Configuring Link Notifications

You can configure which linkUp/linkDown notifications to enable on a device. You can enable the following types of linkUp/linkDown notifications:

- **cieLinkDown**—Enables the Inspur extended link state down notification.
- **cieLinkUp**—Enables the Inspur extended link state up notification.
- **Inspur-xcvr-mon-status-chg**—Enables the Inspur interface transceiver monitor status change notification.
- **delayed-link-state-change**—Enables the delayed link state change.
- **extended-linkUp**—Enables the Internet Engineering Task Force (IETF) extended link state up notification.
- **extended-linkDown**—Enables the IETF extended link state down notification.
- **linkDown**—Enables the IETF Link state down notification.
- **linkUp**—Enables the IETF Link state up notification.

Procedure

	Command or Action	Purpose
Step 1	configure terminal Example: <pre>switch# configure terminal switch(config)#</pre>	Enters global configuration mode.
Step 2	snmp-server enable traps link [cieLinkDown cieLinkUp inspur-xcvr-mon-status-chg delayed-link-state-change] extended-linkUp extended-linkDown linkDown linkUp] Example: <pre>switch(config)# snmp-server enable traps link cieLinkDown</pre>	Enables the link SNMP notifications.

Disabling Link Notifications on an Interface

You can disable linkUp and linkDown notifications on an individual interface. You can use these limit notifications on a flapping interface (an interface that transitions between up and down repeatedly).

Procedure

	Command or Action	Purpose
Step 1	switch# configure terminal	Enters global configuration mode.
Step 2	switch(config)# interface <i>type slot/port</i>	Specifies the interface to be changed.
Step 3	switch(config -if)# no snmp trap link-status	Disables SNMP link-state traps for the interface. This feature is enabled by default.

Enabling One-Time Authentication for SNMP over TCP

You can enable a one-time authentication for SNMP over a TCP session.

Command	Purpose
switch(config)# snmp-server tcp-session [auth]	Enables a one-time authentication for SNMP over a TCP session. This feature is disabled by default.

Assigning SNMP Switch Contact and Location Information

You can assign the switch contact information, which is limited to 32 characters (without spaces), and the switch location.

Procedure

	Command or Action	Purpose
Step 1	switch# configuration terminal	Enters global configuration mode.
Step 2	switch(config)# snmp-server contact <i>name</i>	Configures sysContact, the SNMP contact name.
Step 3	switch(config)# snmp-server location <i>name</i>	Configures sysLocation, the SNMP location.
Step 4	switch# show snmp	(Optional) Displays information about one or more destination profiles.

	Command or Action	Purpose
Step 5	switch# copy running-config startup-config	(Optional) Saves this configuration change.

Configuring the Context to Network Entity Mapping

You can configure an SNMP context to map to a logical network entity, such as a protocol instance or VRF.

Procedure

	Command or Action	Purpose
Step 1	switch# configuration terminal	Enters global configuration mode.
Step 2	switch(config)# snmp-server context <i>context-name</i> [instance <i>instance-name</i>] [vrf <i>vrf-name</i>] [topology <i>topology-name</i>]	Maps an SNMP context to a protocol instance, VRF, or topology. The names can be any alphanumeric string up to 32 characters.
Step 3	switch(config)# snmp-server mib community-map <i>community-name</i> context <i>context-name</i>	Maps an SNMPv2c community to an SNMP context. The names can be any alphanumeric string up to 32 characters.
Step 4	switch(config)# no snmp-server context <i>context-name</i> [instance <i>instance-name</i>] [vrf <i>vrf-name</i>] [topology <i>topology-name</i>]	(Optional) Deletes the mapping between an SNMP context and a protocol instance, VRF, or topology. The names can be any alphanumeric string up to 32 characters. Note Do not enter an instance, VRF, or topology to delete a context mapping. If you use the instance , vrf , or topology keywords, you configure a mapping between the context and a zero-length string.

Configuring the SNMP Local Engine ID

You can configure the engine ID on a local device.



Note

After you configure the SNMP local engine ID, you must reconfigure all SNMP users, any host configured with the V3 users, and the community strings. You need to reconfigure only the SNMP users and community strings.

Procedure

	Command or Action	Purpose
Step 1	configure terminal Example: switch# configure terminal switch(config)#	Enters global configuration mode.
Step 2	snmp-server engineID local <i>engineid-string</i> Example: switch(config)# snmp-server engineID local AA:BB:CC:1A:2C:10	Changes the SNMP engineID of the local device. The local engine ID should be configured as a list of colon-specified hexadecimal octets, where there are even number of hexadecimal characters that range from 10 to 64 and every two hexadecimal characters are separated by a colon. For example, i80:00:02:b8:04:61:62:63.
Step 3	show snmp engineID Example: switch(config)# show snmp engineID	Displays the identification of the configured SNMP engine.
Step 4	[no] snmp-server engineID local <i>engineid-string</i> Example: switch(config)# no snmp-server engineID local AA:BB:CC:1A:2C:10	Disables the local engine ID and the default auto-generated engine ID is configured.
Step 5	copy running-config startup-config Example: switch(config)# copy running-config startup-config	Copies the running configuration to the startup configuration.

Disabling SNMP

Procedure

	Command or Action	Purpose
Step 1	configure terminal Example: switch# configure terminal switch(config)#	Enters global configuration mode.
Step 2	switch(config) # no snmp-server protocol enable	Disables SNMP.

	Command or Action	Purpose
	Example: <pre>no snmp-server protocol enable</pre>	SNMP is disabled by default.

Verifying the SNMP Configuration

To display SNMP configuration information, perform one of the following tasks:

Command	Purpose
show snmp	Displays the SNMP status.
show snmp community	Displays the SNMP community strings.
show interface snmp-ifindex	Displays the SNMP ifIndex value for all interfaces (from IF-MIB).
show running-config snmp [all]	Displays the SNMP running configuration.
show snmp engineID	Displays the SNMP engineID.
show snmp group	Displays SNMP roles.
show snmp sessions	Displays SNMP sessions.
show snmp context	Displays the SNMP context mapping.
show snmp host	Displays information about configured SNMP hosts.
show snmp source-interface	Displays information about configured source interfaces.
show snmp trap	Displays the SNMP notifications enabled or disabled.
show snmp user	Displays SNMPv3 users.

Configuring RMON

This chapter contains the following sections:

- [Information About RMON, page 201](#)
- [Configuration Guidelines and Limitations for RMON, page 202](#)
- [Verifying the RMON Configuration, page 203](#)
- [Default RMON Settings, page 203](#)
- [Configuring RMON Alarms, page 203](#)
- [Configuring RMON Events, page 204](#)

Information About RMON

RMON is an Internet Engineering Task Force (IETF) standard monitoring specification that allows various network agents and console systems to exchange network monitoring data. The Inspur INOS-CN supports RMON alarms, events, and logs to monitor Inspur CN6000device.

An RMON alarm monitors a specific management information base (MIB) object for a specified interval, triggers an alarm at a specified threshold value (threshold), and resets the alarm at another threshold value. You can use alarms with RMON events to generate a log entry or an SNMP notification when the RMON alarm triggers.

RMON is disabled by default and no events or alarms are configured in Inspur CN6000devices. You can configure your RMON alarms and events by using the CLI or an SNMP-compatible network management station.

RMON Alarms

You can set an alarm on any MIB object that resolves into an SNMP INTEGER type. The specified object must be an existing SNMP MIB object in standard dot notation (for example, 1.3.6.1.2.1.2.2.1.17 represents ifOutOctets.17).

When you create an alarm, you specify the following parameters:

- MIB object to monitor

- Sampling interval—The interval that the Inspur CN6000 device uses to collect a sample value of the MIB object.
- Sample type—Absolute samples take the current snapshot of the MIB object value. Delta samples take two consecutive samples and calculate the difference between them.
- Rising threshold—The value at which the Inspur CN6000 device triggers a rising alarm or resets a falling alarm.
- Falling threshold—The value at which the Inspur CN6000 device triggers a falling alarm or resets a rising alarm.
- Events—The action that the Inspur CN6000 device takes when an alarm (rising or falling) triggers.



Note Use the `hcalarms` option to set an alarm on a 64-bit integer MIB object.

For example, you can set a delta type rising alarm on an error counter MIB object. If the error counter delta exceeds this value, you can trigger an event that sends an SNMP notification and logs the rising alarm event. This rising alarm does not occur again until the delta sample for the error counter drops below the falling threshold.



Note The falling threshold must be less than the rising threshold.

RMON Events

You can associate a particular event to each RMON alarm. RMON supports the following event types:

- SNMP notification—Sends an SNMP risingAlarm or fallingAlarm notification when the associated alarm triggers.
- Log—Adds an entry in the RMON log table when the associated alarm triggers.
- Both—Sends an SNMP notification and adds an entry in the RMON log table when the associated alarm triggers.

You can specify a different event for a falling alarm and a rising alarm.

Configuration Guidelines and Limitations for RMON

RMON has the following configuration guidelines and limitations:

- You must configure an SNMP user and a notification receiver to use the SNMP notification event type.
- You can only configure an RMON alarm on a MIB object that resolves to an integer.

Verifying the RMON Configuration

Use the following commands to verify the RMON configuration information:

Command	Purpose
<code>show rmon alarms</code>	Displays information about RMON alarms.
<code>show rmon events</code>	Displays information about RMON events.
<code>show rmon hcalarms</code>	Displays information about RMON hcalarms.
<code>show rmon logs</code>	Displays information about RMON logs.

Default RMON Settings

The following table lists the default settings for RMON parameters.

Table 30: Default RMON Parameters

Parameters	Default
Alarms	None configured.
Events	None configured.

Configuring RMON Alarms

You can configure RMON alarms on any integer-based SNMP MIB object.

You can optionally specify the following parameters:

- The eventnumber to trigger if the rising or falling threshold exceeds the specified limit.
- The owner of the alarm.

Ensure you have configured an SNMP user and enabled SNMP notifications.

Before You Begin

Ensure you have configured an SNMP user and enabled SNMP notifications.

Procedure

	Command or Action	Purpose
Step 1	switch# configure terminal	Enters global configuration mode.
Step 2	switch(config)# rmon alarm <i>index mib-object sample-interval</i> { absolute delta } rising-threshold <i>value</i> [<i>event-index</i>] falling-threshold <i>value</i> [<i>event-index</i>] [owner name]	Creates an RMON alarm. The value range is from –2147483647 to 2147483647. The owner name can be any alphanumeric string.
Step 3	switch(config)# rmon hcalarm <i>index mib-object sample-interval</i> { absolute delta } rising-threshold-high <i>value</i> rising-threshold-low <i>value</i> [<i>event-index</i>] falling-threshold-high <i>value</i> falling-threshold-low <i>value</i> [<i>event-index</i>] [owner name] [storagetype <i>type</i>]	Creates an RMON high-capacity alarm. The value range is from –2147483647 to 2147483647. The owner name can be any alphanumeric string. The storage type range is from 1 to 5.
Step 4	switch# show rmon { alarms hcalarms }	(Optional) Displays information about RMON alarms or high-capacity alarms.
Step 5	switch# copy running-config startup-config	(Optional) Saves this configuration change.

The following example shows how to configure RMON alarms:

```
switch# configure terminal
switch(config)# rmon alarm 1 1.3.6.1.2.1.2.2.1.17.83886080 5 delta rising-threshold 5
1 falling-threshold 0 owner test
switch(config)# exit
switch# show rmon alarms
Alarm 1 is active, owned by test
Monitors 1.3.6.1.2.1.2.2.1.17.83886080 every 5 second(s)
Taking delta samples, last value was 0
Rising threshold is 5, assigned to event 1
Falling threshold is 0, assigned to event 0
On startup enable rising or falling alarm
```

Configuring RMON Events

You can configure RMON events to associate with RMON alarms. You can reuse the same event with multiple RMON alarms.

Ensure you have configured an SNMP user and enabled SNMP notifications.

Before You Begin

Ensure that you have configured an SNMP user and enabled SNMP notifications.

Procedure

	Command or Action	Purpose
Step 1	switch# configure terminal	Enters global configuration mode.
Step 2	switch(config)# rmon event index [description string] [log] [trap] [owner name]	Configures an RMON event. The description string and owner name can be any alphanumeric string.
Step 3	switch(config)# show rmon {alarms hcalarms}	(Optional) Displays information about RMON alarms or high-capacity alarms.
Step 4	switch# copy running-config startup-config	(Optional) Saves this configuration change.

Configuring SPAN

This chapter contains the following sections:

- [Information About SPAN, page 207](#)
- [SPAN Sources, page 208](#)
- [Characteristics of Source Ports, page 208](#)
- [SPAN Destinations, page 208](#)
- [Characteristics of Destination Ports, page 209](#)
- [Guidelines and Limitations for SPAN, page 209](#)
- [Creating or Deleting a SPAN Session, page 210](#)
- [Configuring an Ethernet Destination Port, page 210](#)
- [Configuring Source Ports, page 211](#)
- [Configuring Source Port Channels or VLANs, page 212](#)
- [Configuring the Description of a SPAN Session, page 213](#)
- [Activating a SPAN Session, page 213](#)
- [Suspending a SPAN Session, page 214](#)
- [Displaying SPAN Information, page 214](#)
- [Configuration Examples for SPAN, page 215](#)

Information About SPAN

The Switched Port Analyzer (SPAN) feature (sometimes called port mirroring or port monitoring) selects network traffic for analysis by a network analyzer. The network analyzer can be a Inspur SwitchProbe or other Remote Monitoring (RMON) probes.

SPAN Sources

SPAN sources refer to the interfaces from which traffic can be monitored. The Inspur CN6000 device supports Ethernet, port channels, and VLANs as SPAN sources. With VLANs, all supported interfaces in the specified VLAN are included as SPAN sources. You can choose the SPAN traffic in the ingress direction, the egress direction, or both directions for Ethernet source interfaces:

- Ingress source (Rx)—Traffic entering the device through this source port is copied to the SPAN destination port.
- Egress source (Tx)—Traffic exiting the device through this source port is copied to the SPAN destination port.

You can also configure SPAN source sessions to filter ingress traffic (Rx) by using VLAN access control lists (VACLs).

Characteristics of Source Ports

A source port, also called a monitored port, is a switched interface that you monitor for network traffic analysis. The switch supports any number of ingress source ports (up to the maximum number of available ports on the switch) and any number of source VLANs.

A source port has these characteristics:

- Can be of Ethernet, port channel, or VLAN port type.
- Without an ACL filter configured, the same source can be configured for multiple sessions as long as either the direction or SPAN destination is different. However, each SPAN RX source should be configured for only one SPAN session with an ACL filter.
- Cannot be a destination port.
- Can be configured with a direction (ingress, egress, or both) to monitor. For VLAN sources, the monitored direction can only be ingress and applies to all physical ports in the group. The RX/TX option is not available for VLAN SPAN sessions.
- Ingress traffic can be filtered by using ACLs so that they mirror only those packets of information that match the ACL criteria.
- Can be in the same or different VLANs.

SPAN Destinations

SPAN destinations refer to the interfaces that monitors source ports. The Inspur CN6000Series device supports Ethernet interfaces as SPAN destinations.

Characteristics of Destination Ports

Each local SPAN session must have a destination port (also called a monitoring port) that receives a copy of traffic from the source ports or VLANs. A destination port has these characteristics:

- Can be any physical port. Source Ethernet and FCoE ports cannot be destination ports.
- Cannot be a source port.
- Cannot be a port channel.
- Does not participate in spanning tree while the SPAN session is active.
- Is excluded from the source list and is not monitored if it belongs to a source VLAN of any SPAN session.
- Receives copies of sent and received traffic for all monitored source ports.

Guidelines and Limitations for SPAN

SPAN has the following guidelines and limitations:

- The same source (ethernet or port-channel) can be a part of multiple sessions. You can configure two monitor sessions with different destinations, but the same source VLAN is not supported.
- Multiple ACL filters are supported on the same source.
- The output of the **show monitor session** command displays all directions for the source VLAN and it does not display any option for the filter VLAN.

For information about a similar ERSPAN limitation, see [Guidelines and Limitations for ERSPAN](#), on [page 222](#)

- ACL filtering is supported only for Rx SPAN. Tx SPAN mirrors all traffics that egresses at the source interface.
- ACL filtering is not supported for IPv6 and MAC ACLs because of ternary content addressable memory (TCAM) width limitations.
- The SPAN TCAM size is 128 or 256, depending on the ASIC. One entry is installed as the default and four are reserved for ERSPAN.

- If the same source is configured in more than one SPAN session, and each session has an ACL filter configured, the source interface is programmed only for the first active SPAN session. Hardware entries programmed for ACEs in other sessions is not included in this source interface.
- Both permit and deny access control entries (ACEs) are treated alike. Packets that match the ACE are mirrored irrespective of whether they have a permit or deny entry in the ACL.



Note A deny ACE does not result in a dropped packet. An ACL configured in a SPAN session determines only whether the packet is mirrored or not.

- It is recommended to use only the RX type of source traffic for SPAN to provide better performance because RX traffic is cut-through, whereas TX is store-and-forward. Hence, when monitoring both directions (RX and TX), the performance is not as good as when monitoring only RX. If you need to monitor both directions of traffic, you can monitor RX on more physical ports to capture both sides of the traffic.

Creating or Deleting a SPAN Session

You create a SPAN session by assigning a session number using the **monitor session** command. If the session already exists, any additional configuration information is added to the existing session.

Procedure

	Command or Action	Purpose
Step 1	switch# configure terminal	Enters global configuration mode.
Step 2	switch(config)# monitor session <i>session-number</i>	Enters the monitor configuration mode. New session configuration is added to the existing session configuration.

The following example shows how to configure a SPAN monitor session:

```
switch# configure terminal
switch(config) # monitor session 2
switch(config) #
```

Configuring an Ethernet Destination Port

You can configure an Ethernet interface as a SPAN destination port.



Note

The SPAN destination port can only be a physical port on the switch.

Procedure

	Command or Action	Purpose
Step 1	switch# configure terminal	Enters global configuration mode.
Step 2	switch(config)# interface ethernet <i>slot/port</i>	Enters interface configuration mode for the Ethernet interface with the specified slot and port. Note To enable the switchport monitor command on virtual ethernet ports, you can use the interface vethernet slot/port command.
Step 3	switch(config-if)# switchport monitor	Enters monitor mode for the specified Ethernet interface. Priority flow control is disabled when the port is configured as a SPAN destination.
Step 4	switch(config-if)# exit	Reverts to global configuration mode.
Step 5	switch(config)# monitor session <i>session-number</i>	Enters monitor configuration mode for the specified SPAN session.
Step 6	switch(config-monitor)# destination interface ethernet <i>slot/port</i>	Configures the Ethernet SPAN destination port. Note To enable the virtual ethernet port as destination interface in the monitor configuration, you can use the destination interface vethernet slot/port command.

The following example shows how to configure an Ethernet SPAN destination port (HIF):

```
switch# configure terminal
switch(config)# interface ethernet100/1/24
switch(config-if)# switchport monitor
switch(config-if)# exit
switch(config)# monitor session 1
switch(config-monitor)# destination interface ethernet100/1/24
switch(config-monitor)#
```

The following example shows how to configure a virtual ethernet (VETH) SPAN destination port:

```
switch# configure terminal
switch(config)# interface vethernet10
switch(config-if)# switchport monitor
switch(config-if)# exit
switch(config)# monitor session 2
switch(config-monitor)# destination interface vethernet10
switch(config-monitor)#
```

Configuring Source Ports

Source ports can only be Ethernet ports.

Procedure

	Command or Action	Purpose
Step 1	switch# configure terminal	Enters global configuration mode.
Step 2	switch(config) # monitor session <i>session-number</i>	Enters monitor configuration mode for the specified monitoring session.
Step 3	switch(config-monitor) # source interface <i>type slot/port [rx tx both]</i>	Adds an Ethernet SPAN source port and specifies the traffic direction in which to duplicate packets. You can enter a range of Ethernet ports. You can specify the traffic direction to duplicate as ingress (Rx), egress (Tx), or both. By default, the direction is both.

The following example shows how to configure an Ethernet SPAN source port:

```
switch# configure terminal
switch(config)# monitor session 2
switch(config-monitor)# filter access-group acl1
switch(config-monitor)# source interface ethernet 1/16
switch(config-monitor)#
```

Configuring Source Port Channels or VLANs

You can configure the source channels for a SPAN session. These ports can be port channels and VLANs. The monitored direction can be ingress, egress, or both and applies to all physical ports in the group.

Procedure

	Command or Action	Purpose
Step 1	switch# configure terminal	Enters global configuration mode.
Step 2	switch(config) # monitor session <i>session-number</i>	Enters monitor configuration mode for the specified SPAN session.
Step 3	switch(config-monitor) # filter access-group <i>access-map</i>	Filters ingress traffic at source ports based on the ACL list. Only packets that match the access-list used by access-map are spanned.
Step 4	switch(config-monitor) # source { interface { port-channel } <i>channel-number [rx tx both]</i> vlan <i>vlan-range</i> }	Configures port channel or VLAN sources. For VLAN sources, the monitored direction is implicit.

The following example shows how to configure a port channel SPAN source:

```
switch# configure terminal
switch(config)# monitor session 2
switch(config-monitor)# filter access-group acl1
```

```
switch(config-monitor) # source interface port-channel 1 rx
switch(config-monitor) # source interface port-channel 3 tx
switch(config-monitor) # source interface port-channel 5 both
switch(config-monitor) #
```

The following example shows how to configure a VLAN SPAN source:

```
switch# configure terminal
switch(config) # monitor session 2
switch(config-monitor) # filter access-group acl1
switch(config-monitor) # source vlan 1
switch(config-monitor) #
```

Configuring the Description of a SPAN Session

For ease of reference, you can provide a descriptive name for a SPAN session.

Procedure

	Command or Action	Purpose
Step 1	switch# configure terminal	Enters global configuration mode.
Step 2	switch(config) # monitor session <i>session-number</i>	Enters monitor configuration mode for the specified SPAN session.
Step 3	switch(config-monitor) # description <i>description</i>	Creates a descriptive name for the SPAN session.

The following example shows how to configure a SPAN session description:

```
switch# configure terminal
switch(config) # monitor session 2
switch(config-monitor) # description monitoring ports eth2/2-eth2/4
switch(config-monitor) #
```

Activating a SPAN Session

The default is to keep the session state shut. You can open a session that duplicates packets from sources to destinations.

Procedure

	Command or Action	Purpose
Step 1	switch# configure terminal	Enters global configuration mode.
Step 2	switch(config) # no monitor session {all <i>session-number</i> } shut	Opens the specified SPAN session or all sessions.

The following example shows how to activate a SPAN session:

```
switch# configure terminal
switch(config) # no monitor session 3 shut
```

Suspending a SPAN Session

By default, the session state is **shut**.

Procedure

	Command or Action	Purpose
Step 1	switch# configure terminal	Enters global configuration mode.
Step 2	switch(config) # monitor session {all session-number} shut	Suspends the specified SPAN session or all sessions.

The following example shows how to suspend a SPAN session:

```
switch# configure terminal
switch(config) # monitor session 3 shut
switch(config) #
```

Displaying SPAN Information

Procedure

	Command or Action	Purpose
Step 1	switch# show monitor [session {all session-number range session-range} [brief]]	Displays the SPAN configuration.

The following example shows how to display SPAN session information:

```
switch# show monitor
SESSION STATE REASON DESCRIPTION
-----
2 up The session is up
3 down Session suspended
4 down No hardware resource
```

The following example shows how to display SPAN session details:

```
switch# show monitor session 2
session 2 : local
          : up
type state
source intf :
source VLANs rx :
           : 100
```

```

tx          :
both       :
filter VLANs : filter not specified
destination ports : Eth3/1

```

Configuration Examples for SPAN

Configuration Example for a SPAN Session

To configure a SPAN session, follow these steps:

Procedure

Step 1 Configure destination ports in access mode and enable SPAN monitoring.

Example:

```

switch# configure terminal
switch(config)# interface ethernet 2/5
switch(config-if)# switchport
switch(config-if)# switchport monitor
switch(config-if)# no shut
switch(config-if)# exit
switch(config)#

```

Step 2 Configure a SPAN session.

Example:

```

switch(config)# no monitor session 3
switch(config)# monitor session 3
switch(config-monitor)# source interface ethernet 2/1-3, ethernet 3/1 rx
switch(config-monitor)# source interface port-channel 2
switch(config-monitor)# source interface sup-eth 0 both
switch(config-monitor)# source vlan 3, 6-8 rx
switch(config-monitor)# source interface ethernet 101/1/1-3
switch(config-monitor)# filter vlan 3-5, 7
switch(config-monitor)# destination interface ethernet 2/5
switch(config-monitor)# no shut
switch(config-monitor)# exit
switch(config)# show monitor session 3
switch(config)# copy running-config startup-config

```

Configuration Example for a Unidirectional SPAN Session

To configure a unidirectional SPAN session, follow these steps:

Procedure

Step 1 Configure destination ports in access mode and enable SPAN monitoring.

Example:

```
switch# configure terminal
switch(config)# interface ethernet 2/5
switch(config-if)# switchport
switch(config-if)# switchport monitor
switch(config-if)# no shut
switch(config-if)# exit
switch(config)#
```

Step 2 Configure a SPAN session.**Example:**

```
switch(config)# no monitor session 3
switch(config)# monitor session 3 rx
switch(config-monitor)# source interface ethernet 2/1-3, ethernet 3/1 rx
switch(config-monitor)# filter vlan 3-5, 7
switch(config-monitor)# destination interface ethernet 2/5
switch(config-monitor)# no shut
switch(config-monitor)# exit
switch(config)# show monitor session 3
switch(config)# copy running-config startup-config
```

Configuration Example for a SPAN ACL

This example shows how to configure a SPAN ACL:

```
switch# configure terminal
switch(config)# ip access-list match_11_pkts
switch(config-acl)# permit ip 11.0.0.0 0.255.255.255 any
switch(config-acl)# exit
switch(config)# ip access-list match_12_pkts
switch(config-acl)# permit ip 12.0.0.0 0.255.255.255 any
switch(config-acl)# exit
switch(config)# vlan access-map span_filter 5
switch(config-access-map)# match ip address match_11_pkts
switch(config-access-map)# action forward
switch(config-access-map)# exit
switch(config)# vlan access-map span_filter 10
switch(config-access-map)# match ip address match_12_pkts
switch(config-access-map)# action forward
switch(config-access-map)# exit
switch(config)# monitor session 1
switch(config-erspan-src)# filter access-group span_filter
```

Configuration Examples for UDF-Based SPAN

This example shows how to configure UDF-based SPAN to match on the inner TCP flags of an encapsulated IP-in-IP packet using the following match criteria:

- Outer source IP address: 10.0.0.2
- Inner TCP flags: Urgent TCP flag is set
- Bytes: Eth Hdr (14) + Outer IP (20) + Inner IP (20) + Inner TCP (20, but TCP flags at 13th byte)
- Offset from packet-start: 14 + 20 + 20 + 13 = 67

- UDF match value: 0x20
- UDF mask: 0xFF

```

udf udf_tcpflags packet-start 67 1
hardware access-list tcam region racl qualify udf udf_tcpflags
copy running-config startup-config
reload
ip access-list acl-udf
  permit ip 10.0.0.2/32 any udf udf_tcpflags 0x20
0xff monitor session 1
  source interface Ethernet 1/1
  filter access-group acl-udf

```

This example shows how to configure UDF-based SPAN to match regular IP packets with a packet signature (DEADBEEF) at 6 bytes after a Layer 4 header start using the following match criteria:

- Outer source IP address: 10.0.0.2
- Inner TCP flags: Urgent TCP flag is set
- Bytes: Eth Hdr (14) + IP (20) + TCP (20) + Payload: 112233445566DEADBEEF7788
- Offset from Layer 4 header start: 20 + 6 = 26
- UDF match value: 0xDEADBEEF (split into two-byte chunks and two UDFs)
- UDF mask: 0xFFFFFFFF

```

udf udf_pktsig_msb header outer 13 26 2
udf udf_pktsig_lsb header outer 13 28 2
hardware access-list tcam region racl qualify udf udf_pktsig_msb
udf_pktsig_lsb copy running-config startup-config
reload
ip access-list acl-udf-pktsig
  permit udf udf_pktsig_msb 0xDEAD 0xFFFF udf udf_pktsig_lsb 0xBEEF
0xFFFF monitor session 1
  source interface Ethernet 1/1 filter
  access-group acl-udf-pktsig

```

CHAPTER 19

Configuring Local SPAN and ERSPAN

This chapter contains the following sections:

- [Information About ERSPAN, page 219](#)
- [Licensing Requirements for ERSPAN, page 221](#)
- [Prerequisites for ERSPAN, page 222](#)
- [Guidelines and Limitations for ERSPAN, page 222](#)
- [Default Settings for ERSPAN, page 225](#)
- [Configuring ERSPAN, page 225](#)
- [Configuration Examples for ERSPAN, page 239](#)
- [Additional References, page 241](#)

Information About ERSPAN

The Inspur INOS-CN system supports the Encapsulated Remote Switching Port Analyzer (ERSPAN) feature on both source and destination ports. ERSPAN transports mirrored traffic over an IP network. The traffic is encapsulated at the source router and is transferred across the network. The packet is decapsulated at the destination router and then sent to the destination interface.

ERSPAN consists of an ERSPAN source session, routable ERSPAN generic routing encapsulation (GRE)-encapsulated traffic, and an ERSPAN destination session. You can separately configure ERSPAN source sessions and destination sessions on different switches. You can also configure ERSPAN source sessions to filter ingress traffic by using ACLs.

ERSPAN Sources

The interfaces from which traffic can be monitored are called ERSPAN sources. Sources designate the traffic to monitor and whether to copy ingress, egress, or both directions of traffic. ERSPAN sources include the following:

- Ethernet ports and port channels.

- VLANs—When a VLAN is specified as an ERSPAN source, all supported interfaces in the VLAN are ERSPAN sources.

ERSPAN source ports have the following characteristics:

- A port configured as a source port cannot also be configured as a destination port.
- ERSPAN does not monitor any packets that are generated by the supervisor, regardless of their source.
- Ingress traffic at source ports can be filtered by using ACLs so that they mirror only those packets of information that match the ACL criteria.

ERSPAN Destinations

ERSPAN destination sessions capture packets sent by ERSPAN source sessions on Ethernet ports or port channels and send them to the destination port. Destination ports receive the copied traffic from ERSPAN sources.

ERSPAN destination sessions are identified by the configured source IP address and ERSPAN ID. This allows multiple source sessions to send ERSPAN traffic to the same destination IP and ERSPAN ID and allows you to have multiple sources terminating at a single destination simultaneously.

ERSPAN destination ports have the following characteristics:

- A port configured as a destination port cannot also be configured as a source port.
- Destination ports do not participate in any spanning tree instance or any Layer 3 protocols.
- Ingress and ingress learning options are not supported on monitor destination ports.
- Host Interface (HIF) port channels and fabric port channel ports are not supported as SPAN destination ports.

ERSPAN Sessions

You can create ERSPAN sessions that designate sources and destinations to monitor.

When configuring ERSPAN source sessions, you must configure the destination IP address. When configuring ERSPAN destination sessions, you must configure the source IP address. See [ERSPAN Sources](#), on page 219 for the properties of source sessions and [ERSPAN Destinations](#), on page 220 for the properties of destination sessions.



Note

Only two ERSPAN or SPAN source sessions can run simultaneously across all switches. Only 23 ERSPAN destination sessions can run simultaneously across all switches.

The following figure shows an ERSPAN configuration.

Figure 1: ERSPAN Configuration

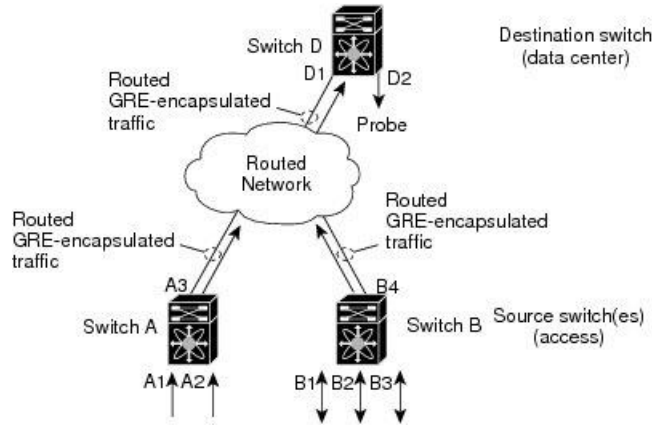

Multiple ERSPAN Sessions

Although you can define up to 18 ERSPAN sessions, only a maximum of four ERSPAN or SPAN sessions can be operational simultaneously. If both receive and transmit sources are configured in the same session, only two ERSPAN or SPAN sessions can be operational simultaneously. You can shut down any unused ERSPAN sessions.

For information about shutting down ERSPAN sessions, see [Shutting Down or Activating an ERSPAN Session, on page 237](#).

High Availability

The ERSPAN feature supports stateless and stateful restarts. After a reboot or supervisor switchover, the running configuration is applied.

Licensing Requirements for ERSPAN

The following table shows the licensing requirements for this feature:

Product	License Requirement
Inspur INOS-CN	ERSPAN requires no license. Any feature not included in a license package is bundled with the Inspur INOS-CN image and is provided at no extra charge to you.

Prerequisites for ERSPAN

ERSPAN has the following prerequisite:

- You must first configure the Ethernet interfaces for ports on each device to support the desired ERSPAN configuration. For more information, see the *Inspur CN6000 Series INOS-CN Interfaces Configuration Guide*.

Guidelines and Limitations for ERSPAN

ERSPAN has the following configuration guidelines and limitations:

- The same source can be part of multiple sessions.
- Multiple ACL filters are supported on the same source.
- ERSPAN supports the following:
 - From 4 to 6 tunnels
 - Nontunnel packets
 - IP-in-IP tunnels
 - IPv4 tunnels (limited)
 - ERSPAN source session type (packets are encapsulated as generic routing encapsulation (GRE)-tunnel packets and sent on the IP network. However, the ERSPAN header is not added to the packet.)
 - ERSPAN destination session type (however, support for decapsulating the ERSPAN packet is not available. The entire encapsulated packet is spanned to a front panel port at the ERSPAN terminating point.)
- ERSPAN packets are dropped if the encapsulated mirror packet fails Layer 2 MTU checks.
- There is a 112-byte limit for egress encapsulation. Packets that exceed this limit are dropped. This scenario might be encountered when tunnels and mirroring are intermixed.
- ERSPAN sessions are shared with local sessions. A maximum of 18 sessions can be configured; however only a maximum of four sessions can be operational at the same time. If both receive and transmit sources are configured in the same session, only two sessions can be operational.
- ERSPAN and ERSPAN ACLs are not supported for packets that are generated by the supervisor.
- ERSPAN and ERSPAN with ACL filtering are not supported for packets generated by the supervisor.

- ACL filtering is supported only for Rx ERSPAN. Tx ERSPAN that mirrors all traffic egressed at the source interface.
- ACL filtering is not supported for IPv6 and MAC ACLs because of TCAM width limitations.
- If the same source is configured in more than one ERSPAN session, and each session has an ACL filter configured, the source interface will be programmed only for the first active ERSPAN session. The ACEs that belong to the other sessions will not have this source interface programmed.
- If you configure an ERSPAN session and a local SPAN session (with filter access-group and allow-sharing option) to use the same source, the local SPAN session goes down when you save the configuration and reload the switch.
- The drop action is not supported with the VLAN access-map configuration with the filter access-group for a monitor session. The monitor session goes into an error state if the VLAN access-map with a drop action is configured with the filter access-group in the monitor session.
- Both permit and deny ACEs are treated alike. Packets that match the ACE are mirrored irrespective of whether they have a permit or deny entry in the ACL.
- ERSPAN is not supported for management ports.
- A destination port can be configured in only one ERSPAN session at a time.
- You cannot configure a port as both a source and destination port.
- A single ERSPAN session can include mixed sources in any combination of the following:
 - Ethernet ports or port channels but not subinterfaces.
 - VLANs or port channels, which can be assigned to port channel subinterfaces.
 - Port channels to the control plane CPU.



Note ERSPAN does not monitor any packets that are generated by the supervisor, regardless of their source.

- Destination ports do not participate in any spanning tree instance or Layer 3 protocols.
- When an ERSPAN session contains source ports that are monitored in the transmit or transmit and receive direction, packets that these ports receive may be replicated to the ERSPAN destination port even though the packets are not actually transmitted on the source ports. Some examples of this behavior on source ports are as follows:
 - Traffic that results from flooding
 - Broadcast and multicast traffic
- For VLAN ERSPAN sessions with both ingress and egress configured, two packets (one from ingress and one from egress) are forwarded from the destination port if the packets get switched on the same VLAN.
- VLAN ERSPAN monitors only the traffic that leaves or enters Layer 2 ports in the VLAN.
- When the Inspur CN6000 Series switch is the ERSPAN destination, GRE headers are not stripped off before sending mirrored packets out of the terminating point. Packets are sent along with the GRE headers as GRE packets and the original packet as the GRE payload.

- The egress interface for the ERSPAN source session is now printed in the output of the **show monitor session <session-number>** CLI command. The egress interface can be a physical port or a port-channel. For ECMP, one interface among the ECMP members is displayed in the output. This particular interface is used for the traffic egress.
- You can view the SPAN/ERSPAN ACL statistics using the **show monitor filter-list** command. The output of the command displays all the entries along with the statistics from the SPAN TCAM. The ACL name is not printed, but only the entries are printed in the output. You can clear the statistics using the **clear monitor filter-list statistics** command. The output is similar to **show ip access-list** command. The Inspur CN6000 Series switch does not provide support per ACL level statistics. This enhancement is supported for both local SPAN and ERSPAN.
- The traffic to and/or from the CPU is spanned. It is similar to any other interface SPAN. This enhancement is supported only in local SPAN. It is not supported with ACL source. The Inspur CN6000 Series switch does not span the packets with (RCPU.dest_port != 0) header that is sent out from the CPU.
- For SPAN forward drop traffic, SPAN only the packets that get dropped due to various reasons in the forwarding plane. This enhancement is supported only for ERSPAN Source session. It is not supported along with SPAN ACL, Source VLAN, and Source interface. Three ACL entries are installed to SPAN dropped traffic. Priority can be set for the drop entries to have a higher/lower priority than the SPAN ACL entries and the VLAN SPAN entries of the other monitor sessions. By default, the drop entries have a higher priority.
- SPAN UDF (User Defined Field) based ACL support
 - You can match any packet header or payload (certain length limitations) in the first 128 bytes of the packet.
 - You can define the UDFs with particular offset and length to match.
 - You can match the length as 1 or 2 bytes only.
 - Maximum of 8 UDFs are supported.
 - Additional UDF match criteria is added to ACL.
 - The UDF match criteria can be configured only for SPAN ACL. This enhancement is not supported for other ACL features, for example, RAACL, PAACL, and VAACL.
 - Each ACE can have up to 8 UDF match criteria.
 - The UDF and http-redirect configuration should not co-exist in the same ACL.
 - The UDF names need to be qualified for the SPAN TCAM.
 - The UDFs are effective only if they are qualified by the SPAN TCAM.
 - The configuration for the UDF definition and the UDF name qualification in the SPAN TCAM require the use of **copy r s** command and reload.
 - The UDF match is supported for both Local SPAN and ERSPAN Src sessions.
 - The UDF name can have a maximum length of 16 characters.
 - The UDF offset starts from 0 (zero). If offset is specified as an odd number, 2 UDFs are used in the hardware for one UDF definition in the software. The configuration is rejected if the number of UDFs usage in the hardware goes beyond 8.
 - The UDF match requires the SPAN TCAM region to go double-wide. Therefore, you have to reduce the other TCAM regions' size to make space for SPAN.

- The SPAN UDFs are not supported in tap-aggregation mode.
- If a sup-eth source interface is configured in the erspan-src session, the acl-span cannot be added as a source into that session and vice-versa.
- IPv6 User Defined Field (UDF) on ERSPAN support
 - Maximum of 8 UDFs are supported across IPv4 and IPv6 ERSPAN ACL monitor sessions.
 - You can have only one *filter ip access-group* or *filter ipv6 access-group* configuration for each monitor session.
 - Maximum of 2 UDFs are supported across spanv6 and spanv6-12. These UDFs can be common and can be shared in both the sessions.
- ERSPAN source and ERSPAN destination sessions must use dedicated loopback interfaces. Such loopback interfaces should not be having any control plane protocols.

Default Settings for ERSPAN

The following table lists the default settings for ERSPAN parameters.

Table 31: Default ERSPAN Parameters

Parameters	Default
ERSPAN sessions	Created in the shut state.

Configuring ERSPAN

Configuring an ERSPAN Source Session

You can configure an ERSPAN session on the local device only. By default, ERSPAN sessions are created in the shut state.

For sources, you can specify Ethernet ports, port channels, and VLANs. A single ERSPAN session can include mixed sources in any combination of Ethernet ports or VLANs.



Note ERSPAN does not monitor any packets that are generated by the supervisor, regardless of their source.

Procedure

	Command or Action	Purpose
Step 1	configure terminal Example: switch# config t switch(config)#	Enters global configuration mode.
Step 2	monitor erspan origin ip-address ip-address global Example: switch(config)# monitor erspan origin ip-address 10.0.0.1 global	Configures the ERSPAN global origin IP address.
Step 3	no monitor session {session-number all} Example: switch(config)# no monitor session 3	Clears the configuration of the specified ERSPAN session. The new session configuration is added to the existing session configuration.
Step 4	monitor session {session-number all} type erspan-source Example: switch(config)# monitor session 3 type erspan-source switch(config-erspan-src)#	Configures an ERSPAN source session.
Step 5	description description Example: switch(config-erspan-src)# description erspan_src_session_3	Configures a description for the session. By default, no description is defined. The description can be up to 32 alphanumeric characters.
Step 6	filter access-group acl-name Example: switch(config-erspan-src)# filter access-group acl1	Filters ingress traffic at source ports based on the ACL list. Only packets that match the access list are spanned. The <i>acl-name</i> is an IP access-list, but not an access-map.
Step 7	source {interface type [rx tx both] vlan {number range} [rx]} Example: switch(config-erspan-src)# source interface ethernet 2/1-3, ethernet 3/1 rx Example: switch(config-erspan-src)# source interface port-channel 2 Example: switch(config-erspan-src)# source interface sup-eth 0 both	Configures the sources and traffic direction in which to copy packets. You can enter a range of Ethernet ports, a port channel, or a range of VLANs. You can configure one or more sources, as either a series of comma-separated entries or a range of numbers. You can specify up to 128 interfaces. For information on the VLAN range, see the <i>Inspur CN6000 INOS-CN Layer 2 Switching Configuration Guide</i> . You can specify the traffic direction to copy as ingress, egress, or both. The default direction is both.

	Command or Action	Purpose
	<p>Example: switch(config-erspan-src)# source vlan 3, 6-8 tx</p> <p>Example: switch(config-monitor)# source interface ethernet 101/1/1-3</p>	
Step 8	Repeat Step 6 to configure all ERSPAN sources.	(Optional) —
Step 9	<p>filter access-group <i>acl-filter</i></p> <p>Example: switch(config-erspan-src)# filter access-group ACL1</p>	<p>(Optional) Associates an ACL with the ERSPAN session.</p> <p>Note You can create an ACL using the standard ACL configuration process. For more information, see the <i>Inspur CN6000 INOS-CN Security Configuration Guide</i>.</p>
Step 10	<p>destination ip <i>ip-address</i></p> <p>Example: switch(config-erspan-src)# destination ip 10.1.1.1</p>	Configures the destination IP address in the ERSPAN session. Only one destination IP address is supported per ERSPAN source session.
Step 11	<p>ip ttl <i>ttl-number</i></p> <p>Example: switch(config-erspan-src)# ip ttl 25</p>	<p>(Optional) Configures the IP time-to-live (TTL) value for the ERSPAN traffic. The range is from 1 to 255.</p>
Step 12	<p>ip dscp <i>dscp-number</i></p> <p>Example: switch(config-erspan-src)# ip dscp 42</p>	<p>(Optional) Configures the differentiated services code point (DSCP) value of the packets in the ERSPAN traffic. The range is from 0 to 63.</p>
Step 13	<p>no shut</p> <p>Example: switch(config-erspan-src)# no shut</p>	<p>Enables the ERSPAN source session. By default, the session is created in the shut state.</p> <p>Note Only two ERSPAN source sessions can be running simultaneously.</p>
Step 14	<p>show monitor session {all <i>session-number</i> <i>range session-range</i>}</p> <p>Example: switch(config-erspan-src)# show monitor session 3</p>	<p>(Optional) Displays the ERSPAN session configuration.</p>
Step 15	<p>show running-config monitor</p> <p>Example: switch(config-erspan-src)# show running-config monitor</p>	<p>(Optional) Displays the running ERSPAN configuration.</p>

	Command or Action	Purpose
Step 16	show startup-config monitor Example: switch(config-erspan-src)# show startup-config monitor	(Optional) Displays the ERSPAN startup configuration.
Step 17	copy running-config startup-config Example: switch(config-erspan-src)# copy running-config startup-config	(Optional) Copies the running configuration to the startup configuration.

Configuring SPAN Forward Drop Traffic for ERSPAN Source Session

Procedure

	Command or Action	Purpose
Step 1	configure terminal Example: switch# config t switch(config)#	Enters global configuration mode.
Step 2	monitor session {<i>session-number</i> all} type erspan-source Example: switch(config)# monitor session 1 type erspan-source switch(config-erspan-src)#	Configures an ERSPAN source session.
Step 3	vrf <i>vrf-name</i> Example: switch(config-erspan-src)# vrf default	Configures the VRF that the ERSPAN source session uses for traffic forwarding.
Step 4	destination ip <i>ip-address</i> Example: switch(config-erspan-src)# destination ip 10.1.1.1	Configures the destination IP address in the ERSPAN session. Only one destination IP address is supported per ERSPAN source session.
Step 5	source forward-drops rx [<i>priority-low</i>] Example: switch(config-erspan-src)# source forward-drops rx [<i>priority-low</i>]	Configures the SPAN forward drop traffic for the ERSPAN source session. When configured as a low priority, this SPAN ACE matching drop condition takes less priority over any other SPAN ACEs configured by the interface ACL SPAN or VLAN ACL SPAN. Without the priority-low keyword, these drop ACEs

	Command or Action	Purpose
		take high priority compared to the regular interface or the VLAN SPAN ACLs. The priority matters only when the packet matching drop ACEs and the interface/VLAN SPAN ACLs are configured.
Step 6	no shut Example: switch(config-erspan-src)# no shut	Enables the ERSPAN source session. By default, the session is created in the shut state. Note Only two ERSPAN source sessions can be running simultaneously.
Step 7	show monitor session {all session-number range session-range} Example: switch(config-erspan-src)# show monitor session 3	(Optional) Displays the ERSPAN session configuration.

```
switch# config t
switch(config)# monitor session 1 type erspan-source
switch(config-erspan-src)# vrf default
switch(config-erspan-src)# destination ip 40.1.1.1
switch(config-erspan-src)# source forward-drops rx
switch(config-erspan-src)# no shut
switch(config-erspan-src)# show monitor session 1
switch# config t
switch(config)# monitor session 1 type erspan-source
switch(config-erspan-src)# vrf default
switch(config-erspan-src)# destination ip 40.1.1.1
switch(config-erspan-src)# source forward-drops rx priority-low
switch(config-erspan-src)# no shut
switch(config-erspan-src)# show monitor session 1
```

Configuring an ERSPAN ACL

You can create an IPv4 ERSPAN ACL on the device and add rules to it.

Before You Begin

To modify the DSCP value or the GRE protocol, you need to allocate a new destination monitor session. A maximum of four destination monitor sessions are supported.

Procedure

	Command or Action	Purpose
Step 1	configure terminal Example: switch# configure terminal switch(config)#	Enters global configuration mode.

	Command or Action	Purpose
Step 2	<p>ip access-list <i>acl-name</i></p> <p>Example: <pre>switch(config)# ip access-list erspan-acl switch(config-acl)#</pre></p>	Creates the ERSPAN ACL and enters IP ACL configuration mode. The <i>acl-name</i> argument can be up to 64 characters.
Step 3	<p>[<i>sequence-number</i>] {permit deny} <i>protocol source destination</i> [set-erspan-dscp <i>dscp-value</i>] [set-erspan-gre-proto <i>protocol-value</i>]</p> <p>Example: <pre>switch(config-acl)# permit ip 192.168.2.0/24 any set-erspan-dscp 40 set-erspan-gre-proto 5555</pre></p>	<p>Creates a rule in the ERSPAN ACL. You can create many rules. The <i>sequence-number</i> argument can be a whole number between 1 and 4294967295.</p> <p>The permit and deny commands support many ways of identifying traffic.</p> <p>The set-erspan-dscp option sets the DSCP value in the ERSPAN outer IP header. The range for the DSCP value is from 0 to 63. The DSCP value configured in the ERSPAN ACL overrides the value configured in the monitor session. If you do not include this option in the ERSPAN ACL, 0 or the DSCP value configured in the monitor session will be set.</p> <p>The set-erspan-gre-proto option sets the protocol value in the ERSPAN GRE header. The range for the protocol value is from 0 to 65535. If you do not include this option in the ERSPAN ACL, the default value of 0x88be will be set as the protocol in the GRE header for ERSPAN-encapsulated packets.</p> <p>Each access control entry (ACE) with the set-erspan-gre-proto or set-erspan-dscp action consumes one destination monitor session. A maximum of three ACEs with one of these actions is supported per ERSPAN ACL. For example, you can configure one of the following:</p> <ul style="list-style-type: none"> • One ERSPAN session with an ACL having a maximum of three ACEs with the set-erspan-gre-proto or set-erspan-dscp action • One ERSPAN session with an ACL having two ACEs with the set-erspan-gre-proto or set-erspan-dscp action and one additional local or ERSPAN session • A maximum of two ERSPAN sessions with an ACL having one ACE with the set-erspan-gre-proto or set-erspan-dscp action
Step 4	<p>show ip access-lists <i>name</i></p> <p>Example: <pre>switch(config-acl)# show ip access-lists erspan-acl</pre></p>	(Optional) Displays the ERSPAN ACL configuration.
Step 5	<p>show monitor session {all <i>session-number</i> range <i>session-range</i>} [brief]</p>	(Optional) Displays the ERSPAN session configuration.

	Command or Action	Purpose
	Example: switch(config-acl)# show monitor session 1	
Step 6	copy running-config startup-config Example: switch(config-acl)# copy running-config startup-config	(Optional) Copies the running configuration to the startup configuration.

Configuring User Defined Field (UDF) Based ACL Support

You can configure User Defined Field (UDF) based ACL support on Inspur CN6000 Series switches. See the following steps to configure ERSPAN based on UDF. See the Guidelines and Limitations for ERSPAN section for more information.

Procedure

	Command or Action	Purpose
Step 1	switch# configure terminal	Enters global configuration mode.
Step 2	switch(config)# udf < udf -name> <packet start> <offset> <length> Example: (config)# udf udf1 packet-start 10 2 (config)# udf udf2 packet-start 50 2	Defines the UDF. Note You can define multiple UDFs but it is recommended to configure only the required UDFs. This configuration takes affect only after attaching the UDFs to a TCAM region and rebooting the box, as the UDFs are added to a region's qualifier set at TCAM carving time (boot up time).
Step 3	switch(config)# udf < udf -name> header <Layer3/Layer4> <offset> <length> Example: (config)# udf udf3 header outer 14 0 1 (config)# udf udf3 header outer 14 10 2 (config)# udf udf3 header outer 14 50 1	Defines the UDF.
Step 4	switch(config)# hardware profile tcam region span qualify udf <name1>..... <name8> Example: (config)# hardware profile tcam region span qualify udf udf1 udf2 udf3 udf4 udf5 [SUCCESS] Changes to UDF qualifier set will be applicable	Configure UDF Qualification in SPAN TCAM. Add the UDFs to qualifier set for a TCAM region at TCAM carving time (happens at boot up time). The configuration allows maximum 4 UDFs that can be attached to a span region, all UDFs listed in a single command for a region. A new configuration for a region replaces the current

	Command or Action	Purpose
	<pre>only after reboot. You need to 'copy run start' and 'reload' config)#</pre>	<p>configuration, but note that it needs a reboot for the configuration to come to the effect.</p> <p>When the UDF qualifier is added to the SPAN TCAM, the TCAM region expands from single wide to double wide. Make sure enough free space (128 more single wide entries) is available for the expansion or else the command gets rejected. Re-enter the command after creating the space by reducing TCAM space from the unused regions. Once the UDFs are detached from SPAN/TCAM region using the no hardware profile tcam region span qualify udf <name1> ..<name8> command, the SPAN TCAM region is considered as a single wide entry.</p>
Step 5	<pre>switch(config)# permit <regular ACE match criteria> udf <name1> < val > <mask> <name8> < val > <mask></pre> <p>Example:</p> <pre>(config)# ip access-list test 10 permit ip any any udf udf1 0x1234 0xffff udf3 0x56 0xff 30 permit ip any any dscp af11 udf udf5 0x22 0x22 config)#</pre>	Configure an ACL with UDF match.
Step 6	<pre>switch(config)# show monitor session <session-number></pre> <p>Example:</p> <pre>(config)# show monitor session 1 session 1 ----- type : erspan-source state : up vrf-name : default destination-ip : 40.1.1.1 ip-ttl : 255 ip-dscp : 0 acl-name : test origin-ip : 100.1.1.10 (global) source intf : rx : Eth1/20 tx : Eth1/20 both : Eth1/20 source VLANs : filter VLANs : filter not specified rx : source fwd drops : egress-intf : Eth1/23 switch# config)#</pre>	Displays the ACL using the show monitor session <session-number> command. You can check if the SPAN TCAM region is carved or not using the BCM SHELL command.

Configuring IPv6 User Defined Field (UDF) on ERSPAN

You can configure IPv6 User Defined Field (UDF) on ERSPAN on Inspur CN6000 Series switches. See the following steps to configure ERSPAN based on IPv6 UDF. See the Guidelines and Limitations for ERSPAN section for more information

Procedure

	Command or Action	Purpose
Step 1	switch# configure terminal	Enters global configuration mode.
Step 2	switch(config)# udf < udf -name> <packet start> <offset> <length> Example: (config)# udf udf1 packet-start 10 2 (config)# udf udf2 packet-start 50 2	Defines the UDF. Note You can define multiple UDFs but it is recommended to configure only the required UDFs. This configuration takes affect only after attaching the UDFs to a TCAM region and rebooting the box, as the UDFs are added to a region's qualifier set at TCAM carving time (boot up time).
Step 3	switch(config)# udf < udf -name> header <Layer3/Layer4> <offset> <length> Example: (config)# udf udf3 header outer 14 0 1 (config)# udf udf3 header outer 14 10 2 (config)# udf udf3 header outer 14 50 1	Defines the UDF.
Step 4	switch(config)# hardware profile tcam region ipv6-span-l2 512 Example: (config)# hardware profile tcam region ipv6-span-12 512 Warning: Please save config and reload the system for the configuration to take effect. config)#	Configure IPv6 on UDF on layer 2 ports. A new configuration for a region replaces the current configuration and you must reboot the switch for the configuration to come to the effect.
Step 5	switch(config)# hardware profile tcam region ipv6-span 512 Example: (config)# hardware profile tcam region ipv6-span 512 Warning: Please save config and reload the system for the configuration to take effect. config)#	Configure IPv6 on UDF on layer 3 ports. A new configuration for a region replaces the current configuration and you must reboot the switch for the configuration to come to the effect.
Step 6	switch(config)# hardware profile tcam region span spanv6 qualify udf <name1>..... <name8>	Configure UDF Qualification in SPAN for layer 3 ports. This enables the UDF match for ipv6-span TCAM region. Add the UDFs to

	Command or Action	Purpose
	<p>Example: <pre>(config)# hardware profile tcam region spanv6 qualify udf udf1</pre> [SUCCESS] Changes to UDF qualifier set will be applicable only after ^{reboot.} You need to 'copy run start' and 'reload' config)#</p>	<p>qualifier set for a TCAM region at TCAM carving time (happens at boot up time). The configuration allows maximum of 2 IPv6 UDFs that can be attached to a SPAN region, all UDFs listed in a single command for a region. A new configuration for a region replaces the current configuration, but note that it needs a reboot for the configuration to come to the effect.</p>
Step 7	<pre>switch(config)# hardware profile tcam region span spanv6-12 qualify udf <name1>..... <name8></pre> <p>Example: <pre>(config)# hardware profile tcam region spanv6-12 qualify udf udf1</pre> [SUCCESS] Changes to UDF qualifier set will be applicable only after ^{reboot.} You need to 'copy run start' and 'reload' config)#</p>	<p>Configure UDF Qualification in SPAN for layer 2 ports. This enables the UDF match for ipv6-span-12 TCAM region. Add the UDFs to qualifier set for a TCAM region at TCAM carving time (happens at boot up time). The configuration allows a maximum of 2 IPv6 UDFs that can be attached to a SPAN region, all UDFs listed in a single command for a region. A new configuration for a region replaces the current configuration, but note that it needs a reboot for the configuration to come to the effect.</p>
Step 8	<pre>switch (config-erspan-src)# filter ipv6 access-group.... <aclname>.... <allow-sharing></pre> <p>Example: <pre>(config-erspan-src)# ipv6 filter access-group test (config)#</pre></p>	<p>Configure a IPv6 ACL in SPAN and ERSPAN mode. You can have only one of “filter ip access-group” or “filter ipv6 access-group” configuration in one monitor session. If same source interface is part of a IPv4 and IPv6 ERSPAN ACL monitor session, the “allow-sharing” needs to be configured with the “filter [ipv6] access-group” in the monitor session configuration.</p>
Step 9	<pre>switch(config)# permit <regular ACE match criteria> udf <name1> < val > <mask> <name8> < val > <mask></pre> <p>Example: <pre>(config-erspan-src)# ipv6 access-list test (config-ipv6-acl)# permit ipv6 any any udf udf1 0x1 0x0</pre></p>	<p>Configure an ACL with UDF match.</p>
Step 10	<pre>switch(config)# show monitor session <session-number></pre> <p>Example: <pre>(config)# show monitor session 1 session 1 ----- type : erspan-source state : up vrf-name : default destination-ip : 40.1.1.1 ip-ttl : 255</pre></p>	<p>Displays the ACL using the show monitor session <session-number> command.</p>

	Command or Action	Purpose
	<pre> ip-dscp : 0 acl-name : test origin-ip : 100.1.1.10 (global) source intf : rx : Eth1/20 tx : Eth1/20 both : Eth1/20 source VLANs : filter VLANs : filter not specified rx : source fwd drops : egress-intf : Eth1/23 switch# config)# </pre>	

Configuring an ERSPAN Destination Session

You can configure an ERSPAN destination session to copy packets from a source IP address to destination ports on the local device. By default, ERSPAN destination sessions are created in the shut state.

Procedure

	Command or Action	Purpose
Step 1	<p>config t</p> <p>Example: <pre> switch# config t switch(config)# </pre> </p>	Enters global configuration mode.
Step 2	<p>interface ethernet slot/port[-port]</p> <p>Example: <pre> switch(config)# interface ethernet 2/5 switch(config-if)# </pre> </p>	Enters interface configuration mode on the selected slot and port or range of ports.
Step 3	<p>switchport</p> <p>Example: <pre> switch(config-if)# switchport </pre> </p>	Configures switchport parameters for the selected slot and port or range of ports.
Step 4	<p>switchport mode [access trunk]</p> <p>Example: <pre> switch(config-if)# switchport mode trunk </pre> </p>	Configures the following switchport modes for the selected slot and port or range of ports: <ul style="list-style-type: none"> • access • trunk
Step 5	Repeat Steps 2 to 4 to configure monitoring on additional ERSPAN destinations.	—

	Command or Action	Purpose
Step 6	no monitor session { <i>session-number</i> all } Example: <pre>switch(config-if)# no monitor session 3</pre>	Clears the configuration of the specified ERSPAN session. The new session configuration is added to the existing session configuration.
Step 7	monitor session { <i>session-number</i> all } type erspan-destination Example: <pre>switch(config-if)# monitor session 3 type erspan-destination switch(config-erspan-dst)#</pre>	Configures an ERSPAN destination session.
Step 8	description <i>description</i> Example: <pre>switch(config-erspan-dst)# description erspan dst session 3</pre>	Configures a description for the session. By default, no description is defined. The description can be up to 32 alphanumeric characters.
Step 9	source ip <i>ip-address</i> Example: <pre>switch(config-erspan-dst)# source ip 10.1.1.1</pre>	Configures the source IP address in the ERSPAN session. Only one source IP address is supported per ERSPAN destination session. This IP address must match the destination IP address configured in the corresponding ERSPAN source session.
Step 10	destination {[interface [<i>type slot/port</i> [- <i>port</i>], [<i>type slot/port</i> [<i>port</i>]]] [port-channel channel-number]} Example: <pre>switch(config-erspan-dst)# destination interface ethernet 2/5</pre>	Configures a destination for copied source packets. You can configure only interfaces as a destination. Note You can configure destination ports as trunk ports.
Step 11	no shut Example: <pre>switch(config)# no shut</pre>	Enables the ERSPAN destination session. By default, the session is created in the shut state. Note Only 16 active ERSPAN destination sessions can be running simultaneously.
Step 12	show monitor session { all <i>session-number</i> range session-range } Example: <pre>switch(config)# show monitor session 3</pre>	(Optional) Displays the ERSPAN session configuration.
Step 13	show running-config monitor Example: <pre>switch(config-erspan-src)# show running-config monitor</pre>	(Optional) Displays the running ERSPAN configuration.

	Command or Action	Purpose
Step 14	show startup-config monitor Example: switch(config-erspan-src)# show startup-config monitor	(Optional) Displays the ERSPAN startup configuration.
Step 15	copy running-config startup-config Example: switch(config-erspan-src)# copy running-config startup-config	(Optional) Copies the running configuration to the startup configuration.

Shutting Down or Activating an ERSPAN Session

You can shut down ERSPAN sessions to discontinue the copying of packets from sources to destinations. Because only a specific number of ERSPAN sessions can be running simultaneously, you can shut down a session to free hardware resources to enable another session. By default, ERSPAN sessions are created in the shut state.

You can enable ERSPAN sessions to activate the copying of packets from sources to destinations. To enable an ERSPAN session that is already enabled but operationally down, you must first shut it down and then enable it. You can shut down and enable the ERSPAN session states with either a global or monitor configuration mode command.

Procedure

	Command or Action	Purpose
Step 1	configuration terminal Example: switch# configuration terminal switch(config)#	Enters global configuration mode.
Step 2	monitor session {<i>session-range</i> all} shut Example: switch(config)# monitor session 3 shut	Shuts down the specified ERSPAN sessions. The session range is from 1-18. By default, sessions are created in the shut state. Four unidirectional sessions, or two bidirectional sessions can be active at the same time.

	Command or Action	Purpose
Step 3	no monitor session { <i>session-range</i> all } shut Example: <pre>switch(config)# no monitor session 3 shut</pre>	Resumes (enables) the specified ERSPAN sessions. The session range is from 1-18. By default, sessions are created in the shut state. Four unidirectional sessions, or two bidirectional sessions can be active at the same time. Note If a monitor session is enabled but its operational status is down, then to enable the session, you must first specify the monitor session shut command followed by the no monitor session shut command.
Step 4	monitor session <i>session-number</i> type erspan-source Example: <pre>switch(config)# monitor session 3 type erspan-source switch(config-erspan-src)#</pre>	Enters the monitor configuration mode for the ERSPAN source type. The new session configuration is added to the existing session configuration.
Step 5	monitor session <i>session-number</i> type erspan-destination Example: <pre>switch(config-erspan-src)# monitor session 3 type erspan-destination</pre>	Enters the monitor configuration mode for the ERSPAN destination type.
Step 6	shut Example: <pre>switch(config-erspan-src)# shut</pre>	Shuts down the ERSPAN session. By default, the session is created in the shut state.
Step 7	no shut Example: <pre>switch(config-erspan-src)# no shut</pre>	Enables the ERSPAN session. By default, the session is created in the shut state.
Step 8	show monitor session all Example: <pre>switch(config-erspan-src)# show monitor session all</pre>	(Optional) Displays the status of ERSPAN sessions.
Step 9	show running-config monitor Example: <pre>switch(config-erspan-src)# show running-config monitor</pre>	(Optional) Displays the running ERSPAN configuration.
Step 10	show startup-config monitor Example: <pre>switch(config-erspan-src)# show startup-config monitor</pre>	(Optional) Displays the ERSPAN startup configuration.

	Command or Action	Purpose
Step 11	copy running-config startup-config Example: switch(config-erspan-src)# copy running-config startup-config	(Optional) Copies the running configuration to the startup configuration.

Verifying the ERSPAN Configuration

Use the following command to verify the ERSPAN configuration information:

Command	Purpose
show monitor session {all session-number range session-range}	Displays the ERSPAN session configuration.
show running-config monitor	Displays the running ERSPAN configuration.
show startup-config monitor	Displays the ERSPAN startup configuration.

Configuration Examples for ERSPAN

Configuration Example for an ERSPAN Source Session

The following example shows how to configure an ERSPAN source session:

```
switch# config t
switch(config)# interface e14/30
switch(config-if)# no shut
switch(config-if)# exit
switch(config)# monitor erspan origin ip-address 3.3.3.3 global
switch(config)# monitor session 1 type erspan-source
switch(config-erspan-src)# filter access-group acl1
switch(config-erspan-src)# source interface e14/30
switch(config-erspan-src)# ip ttl 16
switch(config-erspan-src)# ip dscp 5
switch(config-erspan-src)# vrf default
switch(config-erspan-src)# destination ip 9.1.1.2
switch(config-erspan-src)# no shut
switch(config-erspan-src)# exit
switch(config)# show monitor session 1
```

Configuration Example for an ERSPAN Destination Session

The following example shows how to configure an ERSPAN destination session:

```
switch# config t
switch(config)# interface e14/29
```

```

switch(config-if)# no shut
switch(config-if)# switchport
switch(config-if)# exit
switch(config)# monitor session 2 type erspan-destination
switch(config-erspan-dst)# source ip 9.1.1.2
switch(config-erspan-dst)# destination interface e14/29
switch(config-erspan-dst)# erspan-id 1
switch(config-erspan-dst)# no shut
switch(config-erspan-dst)# exit
switch(config)# show monitor session 2
switch# config t
switch(config)# interface e14/29
switch(config-if)# no shut
switch(config-if)# switchport
switch(config-if)# exit
switch(config)# monitor session 2 type erspan-destination
switch(config-erspan-dst)# source ip 9.1.1.2
switch(config-erspan-dst)# destination interface e14/29
switch(config-erspan-dst)# erspan-id 1
switch(config-erspan-dst)# no shut
switch(config-erspan-dst)# exit
switch(config)# show monitor session 2

```

Configuration Example for an ERSPAN ACL

This example shows how to configure an ERSPAN ACL:

```

switch# configure terminal
switch(config)# ip access-list match_11_pkts
switch(config-acl)# permit ip 11.0.0.0 0.255.255.255 any
switch(config-acl)# exit
switch(config)# ip access-list match_12_pkts
switch(config-acl)# permit ip 12.0.0.0 0.255.255.255 any
switch(config-acl)# exit
switch(config)# vlan access-map erspan_filter 5
switch(config-access-map)# match ip address match_11_pkts
switch(config-access-map)# action forward
switch(config-access-map)# exit
switch(config)# vlan access-map erspan_filter 10
switch(config-access-map)# match ip address match_12_pkts
switch(config-access-map)# action forward
switch(config-access-map)# exit
switch(config)# monitor session 1 type erspan-source
switch(config-erspan-src)# filter access_group erspan_filter

```

Configuration Examples for UDF-Based ERSPAN

This example shows how to configure UDF-based ERSPAN to match on the inner TCP flags of an encapsulated IP-in-IP packet using the following match criteria:

- Outer source IP address: 10.0.0.2
- Inner TCP flags: Urgent TCP flag is set
- Bytes: Eth Hdr (14) + Outer IP (20) + Inner IP (20) + Inner TCP (20, but TCP flags at 13th byte)
- Offset from packet-start: 14 + 20 + 20 + 13 = 67
- UDF match value: 0x20

- UDF mask: 0xFF

```

udf udf_tcpflags packet-start 67 1
hardware access-list tcam region racl qualify udf udf_tcpflags
copy running-config startup-config
reload
ip access-list acl-udf
  permit ip 10.0.0.2/32 any udf udf_tcpflags 0x20
0xff monitor session 1 type erspan-source
  source interface Ethernet 1/1
  filter access-group acl-udf

```

This example shows how to configure UDF-based ERSPAN to match regular IP packets with a packet signature (DEADBEEF) at 6 bytes after a Layer 4 header start using the following match criteria:

- Outer source IP address: 10.0.0.2
- Inner TCP flags: Urgent TCP flag is set
- Bytes: Eth Hdr (14) + IP (20) + TCP (20) + Payload: 112233445566DEADBEEF7788
- Offset from Layer 4 header start: 20 + 6 = 26
- UDF match value: 0xDEADBEEF (split into two-byte chunks and two UDFs)
- UDF mask: 0xFFFFFFFF

```

udf udf_pktsig_msb header outer 13 26 2
udf udf_pktsig_lsb header outer 13 28 2
hardware access-list tcam region racl qualify udf udf_pktsig_msb
udf_pktsig_lsb copy running-config startup-config
reload
ip access-list acl-udf-pktsig
  permit udf udf_pktsig_msb 0xDEAD 0xFFFF udf udf_pktsig_lsb 0xBEEF
0xFFFF monitor session 1 type erspan-source
  source interface Ethernet 1/1 filter
  access-group acl-udf-pktsig

```

CHAPTER 20

Configuring Graceful Insertion and Removal

This chapter describes how to configure graceful insertion and removal (GIR) on the Inspur CN6000 Series switches.

- [About Graceful Insertion and Removal, page 243](#)
- [GIR Workflow, page 245](#)
- [Configuring the Maintenance-Mode Profile, page 246](#)
- [Configuring the Normal-Mode Profile, page 247](#)
- [Creating a Snapshot, page 248](#)
- [Adding Show Commands to Snapshots, page 250](#)
- [Triggering Graceful Removal, page 251](#)
- [Triggering Graceful Insertion, page 253](#)
- [Maintenance Mode Enhancements, page 254](#)
- [Verifying the GIR Configuration, page 255](#)

About Graceful Insertion and Removal

You can use graceful insertion and removal to gracefully eject a switch and isolate it from the network in order to perform debugging or upgrade operations. The switch is removed from the regular forwarding path with minimal traffic disruption. When you are finished performing debugging or upgrade operations, you can use graceful insertion to return the switch to its fully operational (normal) mode.

In graceful removal, all protocols and vPC domains are gracefully brought down and the switch is isolated from the network. In graceful insertion, all protocols and vPC domains are restored.

The following protocols are supported (for both IPv4 and IPv6 address families):

- Border Gateway Protocol (BGP)
- Enhanced Interior Gateway Routing Protocol (EIGRP)
- Intermediate System-to-Intermediate System (ISIS)

- Open Shortest Path First (OSPF)
- Protocol Independent Multicast (PIM)
- Routing Information Protocol (RIP)

**Note**

For graceful insertion and removal, the PIM protocol is applicable only to vPC environments. During graceful removal, the vPC forwarding role is transferred to the vPC peer for all northbound sources of multicast traffic.

Profiles

By default, the system isolates all enabled protocols during graceful removal and restores them during graceful insertion. The protocols are isolated and restored in a predefined order.

If you want to isolate, shut down, or restore the protocols individually (or perform additional configurations), you can create a profile with configuration commands that can be applied during graceful removal or graceful insertion. However, you need to make sure that the order of the protocols is correct and any dependencies are considered.

The switch supports the following profiles:

- Maintenance-mode profile—Contains all the commands that will be executed during graceful removal, when the switch enters maintenance mode.
- Normal-mode profile—Contains all the commands that will be executed during graceful insertion, when the switch returns to normal mode.

The following commands (along with any configuration commands) are supported in the profiles:

Command	Description
isolate	Isolates the protocol from the switch and puts the protocol in maintenance mode.
no isolate	Restores the protocol and puts the protocol in normal mode.
shutdown	Shuts down the protocol or vPC domain.
no shutdown	Brings up the protocol or vPC domain.

Command	Description
sleep instance <i>instance-number seconds</i>	Delays the execution of the command by a specified number of seconds. You can delay multiple instances of the command. The range for the <i>instance-number</i> and <i>seconds</i> arguments is from 0 to 2177483647.
python instance <i>instance-number uri [python-arguments]</i> Example: python instance 1 bootflash://script1.py	Configures Python script invocations to the profile. You can add multiple invocations of the command to the profile. You can enter a maximum of 32 alphanumeric characters for the Python arguments.

Snapshots

In Inspur INOS-CN, a snapshot is the process of capturing the running states of selected features and storing them on persistent storage media.

Snapshots are useful to compare the state of a switch before graceful removal and after graceful insertion.

The snapshot process consists of three parts:

- Creating a snapshot of the states of a few preselected features on the switch and storing them on the persistent storage media
- Listing the snapshots taken at various time intervals and managing them
- Comparing snapshots and showing the differences between features

GIR Workflow

Follow these steps to complete the graceful insertion and removal (GIR) workflow:

- 1 (Optional) Create the maintenance-mode profile. (See [Configuring the Maintenance-Mode Profile](#), on page 246.)
- 2 (Optional) Create the normal-mode profile. (See [Configuring the Normal-Mode Profile](#), on page 247.)
- 3 Take a snapshot before triggering graceful removal. (See [Creating a Snapshot](#), on page 248.)
- 4 Trigger graceful removal to put the switch in maintenance mode. (See [Triggering Graceful Removal](#), on page 251.)
- 5 Trigger graceful insertion to return the switch to normal mode. (See [Triggering Graceful Insertion](#), on page 253.)
- 6 Take a snapshot after triggering graceful insertion. (See [Creating a Snapshot](#), on page 248.)
- 7 Use the **show snapshots compare** command to compare the operational data before and after the graceful removal and insertion of the switch to make sure that everything is running as expected. (See [Verifying the GIR Configuration](#), on page 255.)

Configuring the Maintenance-Mode Profile

You can create a maintenance-mode profile with configuration commands that can be applied during graceful removal or graceful insertion.

Procedure

	Command or Action	Purpose
Step 1	configure maintenance profile maintenance-mode Example: <pre>switch# configure maintenance profile maintenance-mode Enter configuration commands, one per line. End with CNTL/Z. switch(config-mm-profile)#</pre>	Enters a configuration session for the maintenance-mode profile. Depending on which protocols you have configured, you must now enter the appropriate commands to bring down the protocols. For a list of supported commands, see Profiles , on page 244.
Step 2	end Example: <pre>switch(config-mm-profile)# end switch#</pre>	Closes the maintenance-mode profile.
Step 3	show maintenance profile maintenance-mode Example: <pre>switch# show maintenance profile maintenance-mode</pre>	Displays the details of the maintenance-mode profile.

This example shows how to create a maintenance-mode profile:

```
switch# configure maintenance profile maintenance-mode
Enter configuration commands, one per line. End with CNTL/Z.
switch(config-mm-profile)# ip pim isolate
switch(config-mm-profile)# vpc domain 10
```

```

switch(config-mm-profile-config-vpc-domain)# shutdown
switch(config-mm-profile)# router bgp 100
switch(config-mm-profile-router)# shutdown
switch(config-mm-profile)# router eigrp 10
switch(config-mm-profile-router)# shutdown
switch(config-mm-profile-router)# address-family ipv6 unicast
switch(config-mm-profile-router-af)# shutdown
switch(config-mm-profile)# system interface shutdown
switch(config-mm-profile)# end

Exit maintenance profile mode.
switch# show maintenance profile maintenance-mode
[Maintenance Mode]
ip pim isolate
vpc domain 10
  shutdown
  router bgp
  100 shutdown
router eigrp
  10 shutdown
  address-family ipv6 unicast
  shutdown
system interface shutdown

```

Configuring the Normal-Mode Profile

You can create a normal-mode profile with configuration commands that can be applied during graceful removal or graceful insertion.

Procedure

	Command or Action	Purpose
Step 1	configure maintenance profile normal-mode Example: <pre>switch# configure maintenance profile normal-mode Enter configuration commands, one per line. End with CNTL/Z. switch(config-mm-profile)#</pre>	Enters a configuration session for the normal-mode profile. Depending on which protocols you have configured, you must now enter the appropriate commands to bring up the protocols. For a list of supported commands, see Profiles, on page 244 .
Step 2	end Example: <pre>switch(config-mm-profile)# end switch#</pre>	Closes the normal-mode profile.
Step 3	show maintenance profile normal-mode Example: <pre>switch# show maintenance profile normal-mode</pre>	Displays the details of the normal-mode profile.

This example shows how to create a maintenance-mode profile:

```

switch# configure maintenance profile normal-mode
switch(config-mm-profile)# no system interface shutdown
switch(config-mm-profile)# router eigrp 10

```

```

switch(config-mm-profile-router)# no shutdown
switch(config-mm-profile-router)# address-family ipv6 unicast
switch(config-mm-profile-router-af)# no shutdown
switch(config-mm-profile)# router bgp 100
switch(config-mm-profile-router)# no shutdown
switch(config-mm-profile)# vpc domain 10
switch(config-mm-profile-config-vpc-domain)# no shutdown
switch(config-mm-profile)# no ip pim isolate
switch(config-mm-profile)# end

```

```

Exit maintenance profile mode.
switch# show maintenance profile normal-mode
[Normal Mode]
no system interface
shutdown router eigrp 10
  no shutdown
  address-family ipv6 unicast
  no shutdown
router bgp 100
  no shutdown
vpc domain 10
  no shutdown
no ip pim isolate

```

Creating a Snapshot

You can create a snapshot of the running states of selected features. When you create a snapshot, a predefined set of **show** commands are run and the outputs are saved.

Procedure

	Command or Action	Purpose
Step 1	<p>snapshot create <i>snapshot-name description</i></p> <p>Example:</p> <pre> switch# snapshot create snap_before_maintenance Taken before maintenance Executing 'show interface'... Done Executing 'show ip route summary vrf all'... Done Executing 'show ipv6 route summary vrf all'... Done Executing 'show bgp sessions vrf all'... Done Executing 'show ip eigrp topology summary'... Done Executing 'show ipv6 eigrp topology summary'... Done Feature 'vpc' not enabled, skipping... Executing 'show ip ospf vrf all'... Done Feature 'ospfv3' not enabled, skipping... Feature 'isis' not enabled, skipping... Feature 'rip' not enabled, skipping... Snapshot 'snap before maintenance' created </pre>	<p>Captures the running state or operational data of selected features and stores the data on persistent storage media.</p> <p>You can enter a maximum of 64 alphanumeric characters for the snapshot name and a maximum of 254 alphanumeric characters for the description.</p> <p>Use the snapshot delete {all <i>snapshot-name</i>} command to</p>

	Command or Action	Purpose
		delete all snapshots or a specific snapshot.
Step 2	<p>show snapshots</p> <p>Example:</p> <pre>switch# show snapshots Snapshot Name Time Description ----- snap_before_maintenance Mon Oct 02 13:53:28 2017 Taken before maintenance</pre>	Displays snapshots present on the switch.
Step 3	<p>show snapshots compare snapshot-name-1 snapshot-name-2 [summary ipv4routes ipv6routes]</p> <p>Example:</p> <pre>switch# show snapshots compare snap_before_maintenance snap_after_maintenance</pre>	<p>Displays a comparison of two snapshots. The summary option displays just enough information to see the overall changes between the two snapshots.</p> <p>The ipv4routes and ipv6routes options display the changes in IPv4 and IPv6 routes between the two snapshots.</p>

The following example shows a summary of the changes between two snapshots:

```
switch# show snapshots compare snapshot1 snapshot2 summary
feature                               snapshot1  snapshot2  changed
basic summary
  # of interfaces                      16         12         *
  # of vlans                            10         4          *
  # of ipv4 routes                       33         3          *
.....
interfaces
  # of eth interfaces                   3          0          *
  # of eth interfaces up                 2          0          *
  # of eth interfaces down               1          0          *
  # of eth interfaces other              0          0          *
  # of vlan interfaces                   3          1          *
  # of vlan interfaces up                 3          1          *
  # of vlan interfaces down              0          0          *
  # of vlan interfaces other             0          1          *
```

```

.....

The following example shows the changes in IPv4 routes between two snapshots:

switch# show snapshots compare snapshot1 snapshot2 ipv4routes
metric                snapshot1      snapshot2      changed
# of routes            33            3              *
# of adjacencies      10            4              *
Prefix                Changed Attribute
-----
23.0.0.0/8            not in snapshot2
10.10.10.1/32         not in snapshot2
21.1.2.3/8            adjacency index has changed from 29 (snapshot1) to 38 (snapshot2)
.....

There were 28 attribute changes detected

```

Adding Show Commands to Snapshots

You can specify additional **show** commands to be captured in snapshots. These **show** commands are defined in user-specified snapshot sections.

Procedure

	Command or Action	Purpose
Step 1	<p>snapshot section add <i>section</i> <i>"show-command" row-id element-key1</i> <i>[element-key2]</i></p> <p>Example: switch# snapshot section add myshow "show ip interface brief" ROW_intf intf-name</p>	<p>Adds a user-specified section to snapshots. The <i>section</i> is used to name the show command output. You can use any word to name the section.</p> <p>The show command must be enclosed in quotation marks. Non-show commands will not be accepted.</p> <p>The <i>row-id</i> argument specifies the tag of each row entry of the show command's XML output. The <i>element-key1</i> and <i>element-key2</i> arguments specify the tags used to distinguish among row entries. In most cases, only the <i>element-key1</i> argument needs to be specified to be able to distinguish among row entries.</p> <p>Note To delete a user-specified section from snapshots, use the snapshot section delete <i>section</i> command.</p>
Step 2	<p>show snapshots sections</p> <p>Example: switch# show snapshots sections</p>	<p>Displays the user-specified snapshot sections.</p>
Step 3	<p>show snapshots compare <i>snapshot-name-1 snapshot-name-2</i> [summary ipv4routes ipv6routes]</p> <p>Example: switch# show snapshots compare snap1 snap2</p>	<p>Displays a comparison of two snapshots.</p> <p>The summary option displays just enough information to see the overall changes between the two snapshots.</p> <p>The ipv4routes and ipv6routes options display the changes in IPv4 and IPv6 routes between the two snapshots.</p>

The following example adds the **show ip interface brief** command to the myshow snapshot section. It also compares two snapshots (snap1 and snap2) and shows the user-specified sections in both snapshots.

```
switch# snapshot section add myshow "show ip interface brief" ROW_intf intf-name
switch# show snapshots sections
user-specified snapshot sections
-----
[myshow]
  cmd: show ip interface brief
  row: ROW_intf
  key1: intf-name
  key2: -
[sect2]
  cmd: show ip ospf vrf all
  row: ROW_ctx
  key1: instance_number
  key2: cname
switch# show snapshots compare snap1 snap2
=====
Feature                Tag                snap1                snap2
=====
[bgp]
-----
.....
[interface]
-----
      [interface:mgmt0]
            vdc lvl in pkts          692310                **692317**
            vdc lvl in mcast        575281                **575287**
            vdc lvl in bcast         77209                 **77210**
            vdc_lvl_in_bytes        63293252              **63293714**
            vdc_lvl_out pkts         41197                 **41198**
            vdc lvl out ucast        33966                 **33967**
            vdc lvl out bytes        6419714               **6419788**
.....
[ospf]
-----
.....
[myshow]
-----
      [interface:Ethernet1/1]
            state                    up                    **down**
            admin state              up                    **down**
.....
```

Triggering Graceful Removal

In order to perform debugging or upgrade operations, you can trigger a graceful removal of the switch, which will eject the switch and isolate it from the network.

Before You Begin

If you want the system to use a maintenance-mode profile that you create, see [Configuring the Maintenance-Mode Profile, on page 246](#).

Procedure

	Command or Action	Purpose
Step 1	configure terminal Example: <pre>switch# configure terminal switch(config)#</pre>	Enters global configuration mode.
Step 2	system mode maintenance [dont-generate-profile timeout value shutdown on-reload reset-reason reason] Example: <pre>switch(config)# system mode maintenance Following configuration will be applied: ip pim isolate router bgp 65502 isolate router ospf pl isolate router ospfv3 pl isolate Do you want to continue (y/n)? [no] y Generating a snapshot before going into maintenance mode Starting to apply commands... Applying : ip pim isolate Applying : router bgp 65502 Applying : isolate Applying : router ospf pl Applying : isolate Applying : router ospfv3 pl Applying : isolate Maintenance mode operation successful.</pre>	Puts all enabled protocols in maintenance mode (using the isolate command). The following options are available: <ul style="list-style-type: none"> • dont-generate-profile—Prevents the dynamic searching of enabled protocols and executes commands configured in a maintenance-mode profile. Use this option if you want the system to use a maintenance-mode profile that you have created. • timeout value—Keeps the switch in maintenance mode for a specified number of minutes. The range is from 5 to 65535. Once the configured time elapses, the switch returns to normal mode automatically. The no system mode maintenance timeout command disables the timer. • shutdown—Shuts down all protocols, vPC domains, and interfaces except the management interface (using the shutdown command). This option is disruptive while the default (which uses the isolate command) is not. • on-reload reset-reason reason—Boots the switch into maintenance mode automatically in the event of a specified system crash. The no system mode maintenance on-reload reset-reason command prevents the switch from being brought up in maintenance mode in the event of a system crash. <p>The maintenance mode reset reasons are as follows:</p> <ul style="list-style-type: none"> ◦ HW_ERROR—Hardware error ◦ SVC_FAILURE—Critical service failure ◦ KERN_FAILURE—Kernel panic ◦ WDOG_TIMEOUT—Watchdog timeout ◦ FATAL_ERROR—Fatal error ◦ LC_FAILURE—Line card failure ◦ MATCH_ANY—Any of the above reasons

	Command or Action	Purpose
		The system prompts you to continue. Enter y to continue or n to terminate the process.
Step 3	show system mode Example: switch(config)# show system mode System Mode: Maintenance	(Optional) Displays the current system mode. The switch is in maintenance mode. You can now perform any desired debugging or upgrade operations on the switch.
Step 4	copy running-config startup-config Example: switch(config)# copy running-config startup-config	(Optional) Copies the running configuration to the startup configuration. This command is required if you want to preserve maintenance mode following a reboot.

This example shows how to shut down all protocols, vPC domains, and interfaces on the switch:

```
switch(config)# system mode maintenance shutdown
```

Following configuration will be applied:

```
vpc domain 10
 shutdown
router bgp 65502
 shutdown
router ospf p1
 shutdown
router ospfv3
 p1 shutdown
system interface shutdown
```

```
Do you want to continue (y/n)? [no] y
```

```
Generating a snapshot before going into maintenance mode
```

```
Starting to apply commands...
```

```
Applying : vpc domain 10
Applying : shutdown
Applying : router bgp 65502
Applying : shutdown
Applying : router ospf p1
Applying : shutdown
Applying : router ospfv3 p1
Applying : shutdown
```

```
Maintenance mode operation successful.
```

This example shows how to automatically boot the switch into maintenance mode if a fatal error occurs:

```
switch(config)# system mode maintenance on-reload reset-reason fatal_error
```

Triggering Graceful Insertion

When you finish performing any debugging or upgrade operations, you can trigger a graceful insertion to restore all protocols.

Before You Begin

If you want the system to use a normal-mode profile that you create, see [Configuring the Maintenance-Mode Profile, on page 246](#).

Procedure

	Command or Action	Purpose
Step 1	configure terminal Example: <pre>switch# configure terminal switch(config)#</pre>	Enters global configuration mode.
Step 2	no system mode maintenance [dont-generate-profile] Example: <pre>switch(config)# no system mode maintenance dont-generate-profile Following configuration will be applied: no ip pim isolate router bgp 65502 no isolate router ospf p1 no isolate router ospfv3 p1 no isolate Do you want to continue (y/n)? [no] y Starting to apply commands... Applying : no ip pim isolate Applying : router bgp 65502 Applying : no isolate Applying : router ospf p1 Applying : no isolate Applying : router ospfv3 p1 Applying : no isolate Maintenance mode operation successful. Generating Current Snapshot</pre>	<p>Puts all enabled protocols in normal mode (using the no isolate command).</p> <p>The dont-generate-profile option prevents the dynamic searching of enabled protocols and executes commands configured in a normal-mode profile. Use this option if you want the system to use a normal-mode profile that you have created.</p> <p>The system prompts you to continue. Enter y to continue or n to terminate the process.</p>
Step 3	show system mode Example: <pre>switch(config)# show system mode System Mode: Normal</pre>	<p>(Optional)</p> <p>Displays the current system mode. The switch is now in normal mode and is fully operational.</p>

Maintenance Mode Enhancements

The following maintenance mode enhancements have been added to Inspur CN6000 Series switches:

- In the system maintenance shutdown mode, the following message is added:
NOTE: The command `system interface shutdown` will shutdown all interfaces excluding `mgmt 0`.
- Entering the CLI command, **system mode maintenance** checks and sends alerts for the orphan ports.
- In isolate mode, when the vPC is configured, the following message is added:
NOTE: If you have vPC orphan interfaces, please ensure `vpc orphan-port suspend` is configured under them, before proceeding further.
- Custom Profile Configuration: A CLI command, **system mode maintenance always-use-custom-profile** is added for custom profile configuration. When you create a custom profile (in maintenance or normal mode), it displays the following message:
Please use the command **system mode maintenance always-use-custom-profile** if you want to always use the custom profile.
- A delay has been added before the `after_maintenance` snapshot is taken. The **no system mode maintenance** command exits once all the configuration for the normal mode has been applied, the mode has been changed to normal mode, and a timer has been started to take the `after_maintenance` snapshot. Once the timer expires, the `after_maintenance` snapshot is taken in the background and a warning syslog, `MODE_SNAPSHOT_DONE` is sent once the snapshot is complete.
The final output of the CLI command **no system mode maintenance** indicates when the `after_maintenance` snapshot is generated:
The `after_maintenance` snapshot will be generated in `<delay>` seconds. After that time, please use `show snapshots compare before_maintenance after_maintenance` to check the health of the system. The timer delay for the `after_maintenance` snapshot is defaulted to 120 seconds but it can be changed by a new configuration command.
The configuration command to change the timer delay for the `after_maintenance` snapshot is **system mode maintenance snapshot-delay <seconds>**. This configuration overrides the default setting of 120 seconds to any value between 0 and 65535 and it is displayed in the ASCII configuration.
A **show** command, **show maintenance snapshot-delay** has also been added to display the current snapshot-delay value. This **show** command supports the XML output.
- A visible CLI indicator has been added to display when the system is in the maintenance mode, for example, `switch (m-mode) #`.
- Support for the SNMP traps has been added when the device moves from the maintenance mode to the normal mode and vice-versa through CLI reload, or system reset. The **snmp-server enable traps mmode cseMaintModeChangeNotify** trap is added to enable changing to the maintenance mode trap notification. The **snmp-server enable traps mmode cseNormalModeChangeNotify** is added to enable changing to the normal mode trap notification. Both the traps are disabled by default.

Verifying the GIR Configuration

To display the GIR configuration, perform one of the following tasks:

Command	Purpose
show interface brief	Displays abbreviated interface information.

Command	Purpose
show maintenance on-reload reset-reasons	Displays the reset reasons for which the switch comes up in maintenance mode. For a description of the maintenance mode reset reasons, see Triggering Graceful Removal, on page 251 .
show maintenance profile [maintenance-mode normal-mode]	Displays the details of the maintenance-mode or normal-mode profile.
show maintenance timeout	Displays the maintenance-mode timeout period, after which the switch automatically returns to normal mode.
show {running-config startup-config} mmode [all]	Displays the maintenance-mode section of the running or startup configuration. The all option includes the default values.
show snapshots	Displays snapshots present on the switch.
show snapshots compare <i>snapshot-name-1</i> <i>snapshot-name-2</i> [summary ipv4routes ipv6routes]	Displays a comparison of two snapshots. The summary option displays just enough information to see the overall changes between the two snapshots. The ipv4routes and ipv6routes options display the changes in IPv4 and IPv6 routes between the two snapshots.
show snapshots dump <i>snapshot-name</i>	Displays the content of each file that was generated when the snapshot was taken.
show snapshots sections	Displays the user-specified snapshot sections.
show system mode	Displays the current system mode.

Using the PCAP SNMP Parser

This chapter contains the following sections:

- [Using the PCAP SNMP Parser, page 257](#)

Using the PCAP SNMP Parser

The PCAP SNMP parser is a tool to analyze SNMP packets captured in .pcap format. It runs on the switch and generates a statistics report for all of the SNMP get, getnext, getbulk, set, trap, and response requests sent to the switch.

To use the PCAP SNMP parser, use one of the following commands:

- **debug packet-analysis snmp [mgmt0 | inband] duration *seconds* [*output-file*] [keep-pcap]**—Captures packets for a specified number of seconds using Tshark, saves them in a temporary .pcap file, and then analyzes them based on this .pcap file.

The results are saved in the output file or printed to the console, if the output file is not specified. The temporary .pcap file will be deleted by default, unless you use the **keep-pcap** option. Packet capture can be performed on the management interface (mgmt0), which is the default, or the inband interface.

Examples:

```
switch# debug packet-analysis snmp duration 100
switch# debug packet-analysis snmp duration 100 bootflash:snmp_stats.log
switch# debug packet-analysis snmp duration 100 bootflash:snmp_stats.log keep-pcap
switch# debug packet-analysis snmp inband duration 100
switch# debug packet-analysis snmp inband duration 100 bootflash:snmp_stats.log switch#
debug packet-analysis snmp inband duration 100 bootflash:snmp_stats.log keep-pcap
```

- **debug packet-analysis snmp *input-pcap-file* [*output-file*]**—Analyzes the captured packets on an existing .pcap file.

Examples:

```
switch# debug packet-analysis snmp bootflash:snmp.pcap
```

```
switch# debug packet-analysis snmp bootflash:snmp.pcap bootflash:snmp_stats.log
```

The following example shows a sample statistics report for the **debug packet-analysis snmp [mgmt0 | inband] duration** command:

```
switch# debug packet-analysis snmp duration
10 Capturing on eth0
36
wireshark-inspur-mtc-dissector: ethertype=0xde09, devicetype=0x0
wireshark-broadcom-rcpu-dissector: ethertype=0xde08, devicetype=0x0
Started analyzing. It may take several minutes, please wait!

Statistics Report
-----
SNMP Packet Capture Duration: 0 seconds
Total Hosts: 1
Total Requests: 18
Total Responses: 18
Total GET: 0
Total GETNEXT: 0
Total WALK: 1 (NEXT: 18)
Total GETBULK: 0
Total BULKWALK: 0 (BULK: 0)
Total SET: 0
Total TRAP: 0
Total INFORM: 0

Hosts          GET  GETNEXT  WALK (NEXT)  GETBULK  BULKWALK (BULK)  SET  TRAP  INFORM  RESPONSE
-----
10.22.27.244   0     0         1 (18)       0         0 (0)           0   0     0       18
Sessions
-----
1

MIB Objects GET  GETNEXT  WALK (NEXT)  GETBULK (Non_rep/Max_rep)  BULKWALK (BULK, Non_rep/Max_rep)
-----
ifName        0     0         1 (18)       0         0

SET          Hosts
-----
0           10.22.27.244
```

Performing Software Maintenance Upgrades (SMUs)

This chapter describes how to perform software maintenance upgrades (SMUs) on Inspur CN6000 Series switches.

This chapter includes the following sections:

- [About SMUs, page 259](#)
- [Prerequisites for SMUs, page 260](#)
- [Guidelines and Limitations for SMUs, page 260](#)
- [Performing a Software Maintenance Upgrade for Inspur INOS-CN, page 261](#)

About SMUs

A software maintenance upgrade (SMU) is a package file that contains fixes for a specific defect. SMUs are created to respond to immediate issues and do not include new features. Typically, SMUs do not have a large impact on device operations. SMU versions are synchronized to the package major, minor, and maintenance versions they upgrade.

The effect of an SMU depends on its type:

- Process restart SMU-Causes a process or group of processes to restart on activation.
- Reload SMU-Causes a parallel reload of supervisors and line cards.

SMUs are not an alternative to maintenance releases. They provide a quick resolution of immediate issues. All defects fixed by SMUs are integrated into the maintenance releases.

**Note**

Activating an SMU does not cause any earlier SMUs, or the package to which the SMU applies, to be automatically deactivated.



Note SMU package files have an .rpm extension.

Package Management

The general procedure for adding and activating SMU packages on the device is as follows:

- 1 Copy the package file or files to a local storage device or file server.
- 2 Add the package or packages on the device using the **install add** command.
- 3 Activate the package or packages on the device using the **install activate** command.
- 4 Commit the current set of packages using the **install commit** command.
- 5 (Optional) Deactivate and remove the package, when desired.

The following figure illustrates the key steps in the package management process.

Figure 2: Process to Add, Activate, and Commit SMU Packages

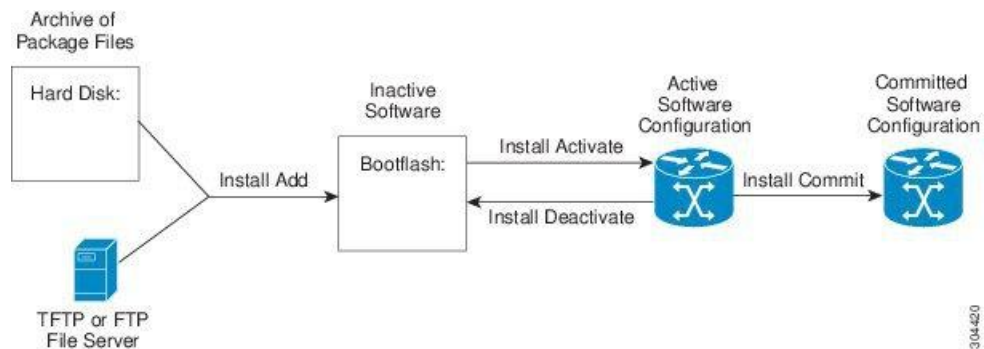

Prerequisites for SMUs

These prerequisites must be met for a package to be activated or deactivated:

- You must be in a user group associated with a task group that includes the proper task IDs. If you suspect a user group assignment is preventing you from using a command, contact your AAA administrator for assistance.
- Verify that all line cards are installed and operating properly. For example, do not activate or deactivate packages while line cards are booting, while line cards are being upgraded or replaced, or when you anticipate an automatic switchover activity.

Guidelines and Limitations for SMUs

SMUs have the following guidelines and limitations:

- Some packages require the activation or deactivation of other packages. If the SMUs have dependencies on each other, you cannot activate them without first activating the previous ones.
- The package being activated must be compatible with the current active software set.
- You cannot activate multiple SMUs in one command.
- Activation is performed only after the package compatibility checks have been passed. If a conflict is found, an error message displays.
- While a software package is being activated, other requests are not allowed to run on any of the impacted nodes. Package activation is completed when a message similar to this one appears:
Install operation 1 completed successfully at Mon Oct 2 01:19:24 2017
- Each CLI install request is assigned a request ID, which can be used later to review the events.
- If you perform a software maintenance upgrade and later upgrade your device to a new Inspur CN6000 software release, the new image overwrites both the previous Inspur CN6000 release and the SMU package file.

Performing a Software Maintenance Upgrade for Inspur INOS-CN

Preparing for Package Installation

You should use several **show** commands to gather information in preparation for the SMU package installation.

Before You Begin

Determine if a software change is required.

Verify that the new package is supported on your system. Some software packages require that other packages or package versions be activated, and some packages support only specific line cards.

Review the release notes for important information related to that release and to help determine the package compatibility with your device configuration.

Verify that the system is stable and prepared for the software changes.

Procedure

	Command or Action	Purpose
Step 1	show install active Example: switch# show install active	Displays the active software on the device. Use this command to determine what software should be added on the device and to compare to the active software report after installation operations are complete.
Step 2	show module Example: switch# show module	Confirms that all modules are in the stable state.

	Command or Action	Purpose
Step 3	show clock Example: switch# show clock	Verifies that the system clock is correct. Software operations use certificates based on device clock times.

This example shows how to display the active packages for the entire system. Use this information to determine if a software change is required.

```
switch# show install active
Active Packages:
Active Packages on Module #3:
Active Packages on Module #6:
Active Packages on Module #7:
Active Packages on Module #22:
Active Packages on Module #30:
```

This example shows how to display the current system clock setting:

```
switch# show clock
02:14:51.474 PST Mon Oct 02 2017
```

Copying the Package File to a Local Storage Device or Network Server

You must copy the SMU package file to a local storage device or a network file server to which the device has access. After this task is done, the package can be added and activated on the device.

If you need to store package files on the device, we recommend that you store the files on the hard disk. The boot device is the local disk from which the package is added and activated. The default boot device is bootflash:.



Tip

Before you copy package files to a local storage device, use the **dir** command to determine if the required package files are already on the device.

If the SMU package files are located on a remote TFTP, FTP, or SFTP server, you can copy the files to a local storage device. After the files are located on the local storage device, the package can be added and activated on the device from that storage device. The following server protocols are supported:

- Trivial File Transfer Protocol—TFTP allows files to be transferred from one computer to another over a network, usually without the use of client authentication (for example, username and password). It is a simplified version of FTP.



Note

Some package files might be larger than 32 MB, and the TFTP services provided by some vendors might not support a file this large. If you do not have access to a TFTP server that supports files larger than 32 MB, download the file using FTP.

- File Transfer Protocol—FTP is part of the TCP/IP protocol stack and requires a username and password.

- SSH File Transfer Protocol—SFTP is part of the SSHv2 feature in the security package and provides for secure file transfers.

After the SMU package file has been transferred to a network file server or the local storage device, you are ready to add and activate the file.

Adding and Activating Packages

You can add SMU package files that are stored on a local storage device or on a remote TFTP, FTP, or SFTP server to your device.



Note The SMU package being activated must be compatible with the currently active software to operate. When an activation is attempted, the system runs an automatic compatibility check to ensure that the package is compatible with the other active software on the device. If a conflict is found, an error message displays. The activation is performed only after all compatibility checks have been passed.



Note This procedure uses Inspur INOS-CN CLI commands to add and activate RPM package files.

Procedure

	Command or Action	Purpose
Step 1	<p>install add <i>filename</i> [activate]</p> <p>Example: Switch# install add bootflash: inos-cn.CSCab00001_TOR-1.0.0- 7.0.3.I7.1.lib32_cn6000.rpm</p>	<p>Unpacks the package software files from the local storage device or network server and adds them to the bootflash: and all active and standby supervisors installed on the device.</p> <p>The filename argument can take any of these formats:</p> <ul style="list-style-type: none"> • bootflash:filename • tfpt://hostname-or-ipaddress/directory-path/filename • ftp://username:password@hostname-or-ipaddress/directory-path/filename • sftp://hostname-or-ipaddress/directory-path/filename
Step 2	<p>show install inactive</p> <p>switch# show install inactive</p>	<p>(Optional)</p> <p>Displays the inactive packages on the device. Verify that the package added in the previous step appears in the display.</p>

	Command or Action	Purpose
Step 3	<p>install activate <i>filename</i> [test]</p> <p>Example: switch# install activate inos-cn.CSCab00001_TOR-1.0.0-7.0.3.I7.1.lib32_cn6000.rpm</p> <p>Example: switch# install activate inos-cn.CSCab00001_TOR-1.0.0-7.0.3.I7.1.lib32_cn6000.rpm Install operation 1 completed successfully at Mon Oct 02 00:42:12 2017</p> <p>Example: switch# install activate inos-cn.CSCab00001_TOR-1.0.0-7.0.3.I7.1.lib32_cn6000.rpm Install operation 2 !!WARNING!! This patch will get activated only after a reload of the switch. At Mon Oct 02 00:42:12 2017</p>	<p>Activates a package that was added to the device. SMU packages remain inactive until activated. (Skip this step if the package was activated earlier with the install add activate command.)</p> <p>Note Press ? after a partial package name to display all possible matches available for activation. If there is only one match, press the Tab key to fill in the rest of the package name.</p>
Step 4	Repeat Step 3 until all packages are activated.	Activates additional packages as required.
Step 5	<p>show install active</p> <p>Example: switch# show install active</p>	<p>(Optional)</p> <p>Displays all active packages. Use this command to determine if the correct packages are active.</p>

Committing the Active Package Set

When an SMU package is activated on the device, it becomes part of the current running configuration. To make the package activation persistent across system-wide reloads, you must commit the package on the device.

Procedure

	Command or Action	Purpose
Step 1	<p>install commit <i>filename</i></p> <p>Example: switch# install commit inos-cn.CSCab00001_TOR-1.0.0-7.0.3.I7.1.lib32_cn6000.rpm</p>	Commits the current set of packages so that these packages are used if the device is restarted.
Step 2	<p>show install committed</p> <p>Example: switch# show install committed</p>	<p>(Optional)</p> <p>Displays which packages are committed.</p>



Deactivating and Removing Packages

When a package is deactivated, it is no longer active on the device, but the package files remain on the boot disk. The package files can be reactivated later, or they can be removed from the disk.



Note This procedure uses Inspur INOS-CN CLI commands to deactivate and remove RPM package files.

Procedure

	Command or Action	Purpose
Step 1	install deactivate <i>filename</i> Example: <pre>switch# install deactivate inos-cn.CSCab00001_TOR-1.0.0- 7.0.3.I7.1.lib32_cn6000.rpm</pre>	Deactivates a package that was added to the device and turns off the package features for the line card. Note Press ? after a partial package name to display all possible matches available for deactivation. If there is only one match, press the Tab key to fill in the rest of the package name.
Step 2	show install inactive Example: <pre>switch# show install inactive</pre>	(Optional) Displays the inactive packages on the device.
Step 3	install commit Example: <pre>switch# install commit</pre>	(Optional) Commits the current set of packages so that these packages are used if the device is restarted. Note Packages can be removed only if the deactivation operation is committed.
Step 4	install remove { <i>filename</i> inactive } Example: <pre>switch# install remove inos-cn.CSCab00001_TOR-1.0.0- 7.0.3.I7.1.lib32_cn6000.rpm Proceed with removing inos-cn.CSCab00001_TOR-1.0.0- 7.0.3.I7.1.lib32_cn6000.rpm? (y/n)? [n] y</pre> Example: <pre>switch# install remove inactive Proceed with removing? (y/n)? [n] y</pre>	(Optional) Removes the inactive package. <ul style="list-style-type: none"> • Only inactive packages can be removed. • Packages can be removed only if they are deactivated from all line cards in the device. • The package deactivation must be committed.

	Command or Action	Purpose
		<ul style="list-style-type: none"> To remove a specific inactive package from a storage device, use the install remove command with the <i>filename</i> argument. To remove all inactive packages from all nodes in the system, use the install remove command with the inactive keyword.

Downgrading Feature RPMs

Follow this procedure to downgrade an installed feature RPM to the base feature RPM.



Note

This procedure uses Inspur INOS-CN CLI commands to downgrade feature RPMs.

Procedure

	Command or Action	Purpose
Step 1	show install packages Example: <pre>switch# show install packages ntp.lib32_cn6000 1.0.1-7.0.3.I7.1 installed</pre>	(Optional) Displays the feature RPM packages on the device.
Step 2	run bash Example: <pre>switch# run bash bash-4.2\$</pre>	Loads Bash.
Step 3	ls *feature* Example: <pre>bash-4.2\$ ls *ntp* ntp-1.0.0-7.0.3.I7.1.lib32_cn6000.rpm</pre>	Lists the RPM for the specified feature.

	Command or Action	Purpose
Step 4	cp filename /bootflash Example: <pre>bash-4.2\$ cp ntp-1.0.0-7.0.3.I7.1.lib32_ cn6000.rpm /bootflash</pre>	Copies the base feature RPM to the bootflash.
Step 5	exit Example: <pre>bash-4.2\$ exit</pre>	Exits Bash.
Step 6	install add bootflash:filename activate downgrade Example: <pre>switch# install add bootflash:ntp-1.0.0-7.0.3.I7.1.lib32 cn6000.rpm activate downgrade Adding the patch (/ntp-1.0.0-7.0.3.I7.1.lib32 cn6000.rpm) [#####] 60% Adding the patch (/ntp-1.0.0-7.0.3.I7.1.lib32 cn6000.rpm) [#####] 100% Install operation 11 completed successfully at Thu Oct 2 15:35:35 2017 Activating the patch (/ntp-1.0.0-7.0.3.I7.1.lib32 cn6000.rpm) This install operation requires system reload. Do you wish to continue (y/n)?: [n] y [217.975959] [1473348971] writing reset reason 132, System reset due to reload patch(es) activation [217.991166] [1473348971]\ufffd\ufffd INSPUR SWITCH Ver Device detected on 0:6:0 after 0 msecs Device detected on 0:1:1 after 0 msecs Device detected on 0:1:0 after 0 msecs MCFrequency 1333Mhz Relocated to memory</pre>	Downgrades the feature RPM. Note If you are prompted to reload the device, enter Y. A reload is required only when downgrading the NTP and SNMP feature RPMs.
Step 7	show install packages i feature Example: <pre>switch# show install packages i ntp ntp.lib32_ cn6000 1.0.0-7.0.3.I7.1 installed</pre>	(Optional) Displays the base feature RPM on the device.

Displaying Installation Log Information

The installation log provides information on the history of the installation operations. Each time an installation operation is run, a number is assigned to that operation.

- Use the **show install log** command to display information about both successful and failed installation operations.

- Use the **show install log** command with no arguments to display a summary of all installation operations. Specify the *request-id* argument to display information specific to an operation. Use the **detail** keyword to display details for a specific operation, including file changes, nodes that could not be reloaded, and any impact to processes.

This example shows how to display information for all installation requests:

```
switch# show install log
Mon Oct 02 01:26:09 2017
Install operation 1 by user 'admin' at Mon Oct 02 01:19:19 2017
Install add bootflash: inos-cn.CSCab00001_TOR-1.0.0-7.0.3.I7.1.lib32_cn6000.rpm
Install operation 1 completed successfully at Mon Oct 02 01:19:24 2017
-----
Install operation 2 by user 'admin' at Mon Oct 02 01:19:29 2017Install
activate inos-cn.CSCab00001_TOR-1.0.0-7.0.3.I7.1.lib32_cn6000.rpm
Install operation 2 completed successfully at Mon Oct 02 01:19:45 2017
-----
Install operation 3 by user 'admin' at Mon Oct 02 01:20:05 2017
Install commit inos-cn.CSCab00001_TOR-1.0.0-
7.0.3.I7.1.lib32_cn6000.rpm
Install operation 3 completed successfully at Mon Oct 02 01:20:08 2017
-----
Install operation 4 by user 'admin' at Mon Oct 02 01:20:21 2017
Install deactivate inos-cn.CSCab00001_TOR-1.0.0-7.0.3.I7.1.lib32_cn6000.rpm
Install operation 4 completed successfully at Mon Oct 02 01:20:36 2017
-----
Install operation 5 by user 'admin' at Mon Oct 02 01:20:43 2017
Install commit inos-cn.CSCab00001_TOR-1.0.0-7.0.3.I7.1.lib32_cn6000.rpm
Install operation 5 completed successfully at Mon Oct 02 01:20:46 2017
-----
Install operation 6 by user 'admin' at Mon Oct 02 01:20:55 2017
Install remove inos-cn.CSCab00001_TOR-1.0.0-7.0.3.I7.1.lib32_cn6000.rpm
Install operation 6 completed successfully at Mon Oct 02 01:20:57 2017
```

Configuring Tap Aggregation and MPLS Stripping

This chapter contains the following sections:

- [Information About Tap Aggregation, page 269](#)
- [Information About MPLS Stripping, page 271](#)
- [Configuring Tap Aggregation, page 272](#)
- [Verifying the Tap Aggregation Configuration, page 275](#)
- [Configuring MPLS Stripping, page 276](#)
- [Verifying the MPLS Label Configuration, page 279](#)

Information About Tap Aggregation

Network Taps

You can use various methods to monitor packets. One method uses physical hardware taps.

Network taps can be extremely useful in monitoring traffic because they provide direct inline access to data that flows through the network. In many cases, it is desirable for a third party to monitor the traffic between two points in the network. If the network between points A and B consists of a physical cable, a network tap might be the best way to accomplish this monitoring. The network tap has at least three ports: an A port, a B port, and a monitor port. A tap inserted between the A and B ports passes all traffic through unimpeded, but it also copies that same data to its monitor port, which could enable a third party to listen.

Taps have the following benefits:

- They can handle full-duplex data transmission
- They are nonobtrusive and not detectable by the network with no physical or logical addressing
- Some taps support full inline power with the capability to build a distributed tap

Whether you are trying to gain visibility into the server-to-server data communication at the edge or virtual edge of your network or to provide a copy of traffic to the Intrusion Prevention System (IPS) appliance at the Internet edge of your network, you can use network taps nearly anywhere in the environment. However, this

deployment can add significant costs, operation complexities, and cabling challenges in a large-scale environment.

Tap Aggregation

An alternative solution to help with monitoring and troubleshooting tasks in the data center is a device that is especially designated to allow the aggregation of multiple taps and that also connects to multiple monitoring systems. This solution is referred to as tap aggregation. Tap aggregation switches link all the monitoring devices directly to specific points in the network fabric that handle the packets that need to be observed.

Figure 3: Tap Aggregation Switch Solution

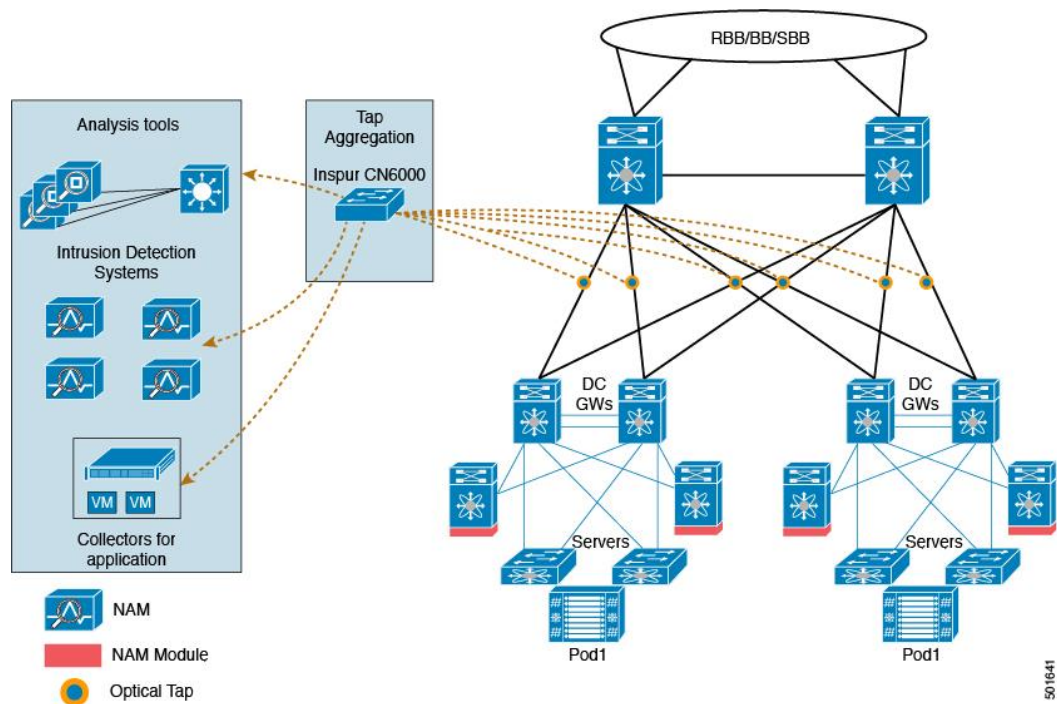

In the tap aggregation switch solution, the Inspur CN6000 Series switches are connected to various points in the network at which packet monitoring is advantageous. From each network element, you can use Switched Port Analyzer (SPAN) ports or optical taps to send traffic flows directly to this tap aggregation switch. The tap aggregation switch itself is directly connected to all the analysis tools used to monitor the events in the network fabric. These monitoring devices include remote monitor (RMON) probes, application firewalls, IPS devices, and packet sniffer tools.

You can dynamically program the tap aggregation switch with a configuration that allows traffic to enter the switch through a certain set of ports that are connected to the network elements. You can also configure a number of match criteria and actions to filter specific traffic and redirect them to one or more tools.

Guidelines and Limitations for Tap Aggregation

Tap aggregation has the following guidelines and limitations:

- The interface to be applied with the tap aggregation policy must be in Layer 2. You can configure a Layer 3 interface with the policy, but the policy becomes nonfunctional.
- Each rule must be associated with only one unique match criterion.
- All tap aggregation interfaces must share the same ACL. Multiple ACLs are not required across interfaces because the match criteria include an ingress interface.
- The actions **vlan-set** and **vlan-strip** must always be specified after the **redirect** action. Otherwise, the entry will be rejected as invalid.
- The deny rule does not support actions such as **redirect**, **vlan-set**, and **vlan-strip**.
- When you enter a list of inputs, for example, a list of interfaces for the policy, you must separate them with commas, but no spaces. For example, port-channel50,ethernet1/12,port-channel20.
- When you specify target interfaces in a policy, ensure that you enter the whole interface type and not just the short form of it. For example, ensure that you enter ethernet1/1 instead of eth1/1 and port-channel 50 instead of po50.

Information About MPLS Stripping

MPLS Overview

Multiprotocol Label Switching (MPLS) integrates the performance and traffic management capabilities of Layer 2 switching with the scalability, flexibility, and performance of Layer 3 routing.

An MPLS architecture provides the following benefits:

- Data can be transferred over any combination of Layer 2 technologies
- Support is offered for all Layer 3 protocols
- Scaling is possible well beyond anything offered in today's networks

MPLS Header Stripping

The ingress ports receive various MPLS packet types. Each data packet in an MPLS network has one or more label headers. These packets are redirected on the basis of a redirect ACL.

A label is a short, four-byte, fixed-length, locally significant identifier that is used to identify a Forwarding Equivalence Class (FEC). The label that is put on a particular packet represents the FEC to which that packet is assigned. It has the following components:

- Label—Label value (unstructured), 20 bits
- Exp—Experimental use, 3 bits; currently used as a Class of Service (CoS) field

- S—Bottom of stack, 1 bit
- TTL—Time to live, 8 bits

Because the MPLS label is imposed between the Layer 2 header and the Layer 3 header, its headers and data are not located at the standard byte offset. Standard network monitoring tools cannot monitor and analyze this traffic. To enable standard network monitoring tools to monitor this traffic, single-labeled packets are stripped off their MPLS label headers and redirected to T-cache devices.

MPLS packets with multiple label headers are sent to deep packet inspection (DPI) devices without stripping their MPLS headers.

Guidelines and Limitations for MPLS Stripping

MPLS stripping has the following guidelines and limitations:

- Disable all Layer 3 and vPC features before you enable MPLS stripping.
- Ensure that global tap-aggregation mode is enabled.
- The ingress and egress interfaces involved in MPLS stripping must have **mode tap-aggregation** enabled.
- You must configure the tap-aggregation ACL with a redirect action on the ingress interface to forward the packet to the desired destination.
- Only one tap ACL is supported on the system.
- The egress interface where stripped packets will exit must be an interface that has VLAN 1 as an allowed VLAN. We recommend that you configure the egress interface as a trunk with all VLANs allowed by default.
- To enable MPLS stripping, ensure that you configure the Control Plane Policing (CoPP) class for MPLS, `copp-s-mpls`.
- For MPLS stripped packets, port-channel load balancing is supported.
- Layer 3 header-based hashing and Layer 4 header-based hashing are supported, but Layer 2 header-based hashing is not supported.
- During MPLS stripping, the VLAN is also stripped with the MPLS label.

Configuring Tap Aggregation

Enabling Tap Aggregation

Ensure that you run the **copy running-config startup-config** command and reload the switch after enabling tap aggregation.

Procedure

	Command or Action	Purpose
Step 1	switch# configure terminal	Enters global configuration mode.
Step 2	switch (config)# [no] hardware profile tap-aggregation [l2drop]	Enables tap aggregation and reserves entries in the interface table that are needed for VLAN tagging. The l2drop option drops non-IP traffic ingress on tap interfaces. The no form of this command disables the feature.
Step 3	switch (config)# copy running-config startup-config	Saves the change persistently through reboots and restarts by copying the running configuration to the startup configuration.
Step 4	switch (config)# reload	Reloads the Inspur INOS-CN software.

This example shows how to configure tap aggregation globally on the switch:

```
switch# configure terminal
switch(config)# hardware profile tap-aggregation
switch(config)# copy running-config startup-config
switch(config)# reload
```

Configuring a Tap Aggregation Policy

You can configure a TAP aggregation policy on an IP access control list (ACL) or on a MAC ACL.

Procedure

	Command or Action	Purpose
Step 1	switch# configure terminal	Enters global configuration mode.
Step 2	<ul style="list-style-type: none"> • switch(config)# ip access-list <i>access-list-name</i> • switch(config)# mac access-list <i>access-list-name</i> 	Creates an IP ACL and enters IP access list configuration mode or creates a MAC ACL and enters MAC access list configuration mode. Note Support for IPv6 ACLs is added on the Inspur CN6000 Series switches. The redirect action is supported in IPv6 ACLs. All the match options that are currently supported for IPv6 PACL are now supported with the redirect action.
Step 3	switch(config-acl)# statistics per-entry	Starts recording statistics for how many packets are permitted or denied by each entry.
Step 4	switch(config-acl)# [no] permit <i>protocol source destination match-criteria action</i>	Creates an IP access control list (ACL) rule that permits traffic to match its conditions.

	Command or Action	Purpose
		<p>The no version of this command removes the permit rule from the policy.</p> <p><i>match-criteria</i> can be one of the following:</p> <ul style="list-style-type: none"> • ingress-intf Note The ingress interface can be a match criteria only on Layer 2—EtherType or port channel • vlan • vlan-priority Note Each policy can have only one rule associated with a unique match criterion. <p><i>action</i> can be one of the following:</p> <ul style="list-style-type: none"> • redirect • priority • set-vlan <p>A tap ACL that matches on non-IP ethertype must be specified with a priority value greater than 0.</p>
Step 5	<pre>switch(config-acl)# [no] deny protocol source destination match-criteria action</pre>	<p>Creates an IP access control list (ACL) rule that denies traffic matching its conditions.</p> <p>The no version of this command removes the deny rule from the policy.</p> <p>It does not support redirect, and vlan-set actions.</p>

This example shows how to configure a tap aggregation policy:

```
switch# configure terminal
switch(config)# ip access-list test
switch(config-acl)# statistics per-entry
switch(config-acl)# permit ip any any ingress-intf Ethernet1/4 redirect Ethernet1/8
switch(config-acl)# permit ip any any ingress-intf Ethernet1/6 redirect
Ethernet1/1,Ethernet1/2,port-channel7,port-channel8,Ethernet1/12,Ethernet1/13
switch(config-acl)# permit tcp any eq www any ingress-intf Ethernet1/10 redirect port-
channel4
switch(config-acl)# deny ip any any
```

Attaching a Tap Aggregation Policy to an Interface

To attach a tap aggregation policy to an interface, enter the tap aggregation mode and apply the ACL configured with tap aggregation to the interface. Ensure that the interface to which you attach the policy is a Layer 2 interface.

Procedure

	Command or Action	Purpose
Step 1	switch# configure terminal	Enters global configuration mode.
Step 2	switch(config)# interface type slot/port	Enters the interface configuration mode for the specified interface.
Step 3	switch (config-if)# [no] mode tap-aggregation	Allows an attachment of the ACL with the match and action criteria. The no form of this command disallows the attachment of an ACL with the tap aggregation policy to the interface. To remove the ACL from the interface, use the no ip port access-group command.
Step 4	switch(config-if)# [no] ip port access-group access-list-name in	Applies an IPv4 access control list (ACL) to an interface as a port ACL. The no form of this command removes an ACL from an interface.

This example shows how to attach a tap aggregation policy to an interface:

```
switch# configure terminal
switch(config)# interface ethernet1/2
switch (config-if)# mode tap-aggregation
switch(config-if)# ip port access-group test in
```

Verifying the Tap Aggregation Configuration

Command	Purpose
show ip access-list access-list-name	Displays all IPv4 access control lists (ACLs) or a specific IPv4 ACL.

This example shows how to display an IPv4 ACL:

```
switch(config)# show ip access-list test
IPv4 ACL test
 10 permit ip any any ethertype 0x800 ingress-intf Ethernet1/4 redirect
Ethernet1/8
 20 permit ip any any ingress-intf Ethernet1/6 redirect
Ethernet1/1,Ethernet1/2,port-channel7,port-channel8,Ethernet1/12,Ethernet1/13
 30 permit tcp any eq www any ethertype 0x800 ingress-intf Ethernet1/10
redirect port-channel4
 40 deny ip any any
```

Configuring MPLS Stripping

Enabling MPLS Stripping

You can enable MPLS stripping globally.

Procedure

	Command or Action	Purpose
Step 1	switch# configure terminal	Enters global configuration mode.
Step 2	switch(config)# [no] mpls strip	Globally enables MPLS stripping. The no form of this command disables MPLS stripping.

The following example shows how to enable MPLS stripping:

```
switch# configure terminal
switch(config)# mpls strip
```

Adding and Deleting MPLS Labels

The device can learn the labels dynamically whenever a frame is received with an unknown label on a mode tap interface. You can also add or delete static MPLS labels by using the following commands:

Before You Begin

- Enable tap aggregation
- Configure tap aggregation policy
- Attach a tap aggregation policy to an interface

Procedure

	Command or Action	Purpose
Step 1	switch# configure terminal	Enters global configuration mode.
Step 2	switch(config)# mpls strip label label	Adds the specified static MPLS label. The value of the label can range from 1 to 1048575.
Step 3	switch(config)# no mpls strip label label all	Deletes the specified static MPLS label. The all option deletes all static MPLS labels.

The following example shows how to add static MPLS labels:

```
switch# configure terminal
switch(config)# mpls strip label 100
switch(config)# mpls strip label 200
switch(config)# mpls strip label 300
```

The following example shows how to delete a static MPLS label:

```
switch# configure terminal
switch(config)# no mpls strip label 200
```

The following example shows how to delete all static MPLS labels:

```
switch# configure terminal
switch(config)# no mpls strip label all
```

Clearing Label Entries

You can clear dynamic label entries from the MPLS label table by using the following command:

Procedure

	Command or Action	Purpose
Step 1	switch# clear mpls strip label dynamic	Clears dynamic label entries from the MPLS label table.

The following example shows how to clear dynamic label entries:

```
switch# clear mpls strip label dynamic
```

Clearing MPLS Stripping Counters

You can clear all software and hardware MPLS stripping counters.

Procedure

	Command or Action	Purpose
Step 1	switch# clear counters mpls strip	Clears all MPLS stripping counters.

The following example shows how to clear all MPLS stripping counters:

```
switch# clear counters mpls strip
switch# show mpls strip labels
MPLS Strip Labels:
  Total      : 15000
  Static     : 2
Legend:     *- Static Label
Interface - where label was first learned
Idle-Age - Seconds since last use
SW-Counter- Packets received in Software
HW-Counter- Packets switched in Hardware
```

Label	Interface	Idle-Age	SW-Counter	HW-Counter
4096	Eth1/44	15	0	0
8192	Eth1/44	17	0	0
12288	Eth1/44	15	0	0
16384	Eth1/44	39	0	0
20480	Eth1/44	47	0	0
24576	Eth1/44	7	0	0
28672	Eth1/44	5	0	0
36864	Eth1/44	7	0	0
40960	Eth1/44	19	0	0
45056	Eth1/44	9	0	0
49152	Eth1/44	45	0	0
53248	Eth1/44	9	0	0

Configuring MPLS Label Aging

You can define the amount of time after which dynamic MPLS labels will age out, if unused.

Procedure

	Command or Action	Purpose
Step 1	switch# configure terminal	Enters global configuration mode.
Step 2	switch(config)# mpls strip label-age <i>age</i>	Specifies the amount of time after which dynamic MPLS labels age out.

The following example shows how to configure label age for dynamic MPLS labels:

```
switch# configure terminal
switch(config)# mpls strip label-age 300
```

Configuring Destination MAC Addresses

You can configure the destination MAC address for stripped egress frames.

Procedure

	Command or Action	Purpose
Step 1	switch# configure terminal	Enters global configuration mode.
Step 2	switch(config)# mpls strip dest-mac <i>mac-address</i>	Specifies the destination MAC address for egress frames that are stripped of their headers. The MAC address can be specified in one of the following four formats: <ul style="list-style-type: none"> • E.E.E • EE-EE-EE-EE-EE-EE • EE:EE:EE:EE:EE:EE

Command or Action	Purpose
	<ul style="list-style-type: none"> • EEEE.EEEE.EEEE

The following example shows how to configure the destination MAC address for egress frames:

```
switch# configure terminal
switch(config)# mpls strip dest-mac 1.1.1
```

Verifying the MPLS Label Configuration

Use the following command to display the MPLS label configuration:

Command	Purpose
<code>show mpls strip labels [label all dynamic static]</code>	<p>Displays information about MPLS labels. You can specify the following options:</p> <ul style="list-style-type: none"> • <i>label</i>—Label to be displayed • all—Specifies that all labels must be displayed. This is the default option. • dynamic—Specifies that only dynamic labels must be displayed. • static—Specifies that only static labels must be displayed.

The following example shows how to display all MPLS labels:

```
switch# show mpls strip labels
MPLS Strip Labels:
  Total      : 3005
  Static     : 5
Legend:     * - Static Label
Interface - where label was first learned
Idle-Age   - Seconds since last use
SW-Counter- Packets received in Software
HW-Counter- Packets switched in Hardware
-----
Label      Interface      Idle-Age  SW-Counter  HW-Counter
-----
4096      Eth1/53/1          15         1           210
4097      Eth1/53/1          15         1           210
4098      Eth1/53/1          15         1           210
4099      Eth1/53/1           7         2           219
4100      Eth1/53/1           7         2           219
4101      Eth1/53/1           7         2           219
4102      Eth1/53/1          39         1           206
4103      Eth1/53/1          39         1           206
4104      Eth1/53/1          39         1           206
4105      Eth1/53/1           1         1           217
4106      Eth1/53/1           1         1           217
4107      Eth1/53/1           1         1           217
4108      Eth1/53/1          15         1           210
* 25000   None <User>        39         1           206
```

```

* 20000 None <User>          39          1          206
* 21000 None <User>          1           1          217

```

The following example shows how to display only static MPLS labels:

```
switch(config)# show mpls strip labels static
```

```
MPLS Strip Labels:
```

```
Total      : 3005
```

```
Static      : 5
```

```
Legend:    * - Static Label
```

```
Interface - where label was first learned
```

```
Idle-Age  - Seconds since last use
```

```
SW-Counter- Packets received in Software
```

```
HW-Counter- Packets switched in Hardware
```

```
-----
```

	Label	Interface	Idle-Age	SW-Counter	HW-Counter
*	300	None <User>	403	0	0
*	100	None <User>	416	0	0
*	25000	None <User>	869	0	0
*	20000	None <User>	869	0	0
*	21000	None <User>	869	0	0

```
-----
```

Configuring sFlow

This chapter contains the following sections:

- [Information About sFlow, page 281](#)
- [Licensing Requirements, page 282](#)
- [Prerequisites, page 282](#)
- [Guidelines and Limitations for sFlow, page 282](#)
- [Default Settings for sFlow, page 282](#)
- [Configuring sFlow, page 283](#)
- [Verifying the sFlow Configuration, page 289](#)
- [Configuration Examples for sFlow, page 289](#)
- [Additional References for sFlow, page 290](#)
- [Feature History for sFlow, page 290](#)

Information About sFlow

sFlow allows you to monitor the real-time traffic in data networks that contain switches and routers. It uses the sampling mechanism in the sFlow Agent software on switches and routers for monitoring traffic and to forward the sample data on ingress and egress ports to the central data collector, also called the sFlow Analyzer.

For more information about sFlow, see RFC 3176.

sFlow Agent

The sFlow Agent, which is embedded in the Inspur INOS-CN software, periodically samples or polls the interface counters that are associated with a data source of the sampled packets. The data source can be an Ethernet interface, an EtherChannel interface, or a range of Ethernet interfaces. The sFlow Agent queries the Ethernet port manager for the respective EtherChannel membership information and also receives notifications from the Ethernet port manager for membership changes.

When you enable sFlow sampling in the Inspur INOS-CN software, based on the sampling rate and the hardware internal random number, the ingress packets and egress packets are sent to the CPU as an sFlow-sampled packet. The sFlow Agent processes the sampled packets and sends an sFlow datagram to the sFlow Analyzer. In addition to the original sampled packet, an sFlow datagram includes the information about the ingress port, egress port, and the original packet length. An sFlow datagram can have multiple sFlow samples.

Licensing Requirements

This feature does not require a license. Any feature not included in a license package is bundled with the Inspur INOS-CN image and is provided at no extra charge to you.

Prerequisites

You must enable the sFlow feature using the **feature sflow** command to configure sFlow.

Guidelines and Limitations for sFlow

The sFlow configuration guidelines and limitations are as follows:

- When you enable sFlow for an interface, it is enabled for both ingress and egress. You cannot enable sFlow for only ingress or only egress.
- sFlow egress sampling for multicast, broadcast, or unknown unicast packets is not supported.
- You should configure the sampling rate based on the sFlow configuration and traffic in the system.
- Inspur CN6000 Series supports only one sFlow collector.

Default Settings for sFlow

Table 32: Default sFlow Parameters

Parameters	Default
sFlow sampling-rate	4096
sFlow sampling-size	128
sFlow max datagram-size	1400
sFlow collector-port	6343
sFlow counter-poll-interval	20

Configuring sFlow

Enabling the sFlow Feature

You must enable the sFlow feature before you can configure sFlow on the switch.

Procedure

	Command or Action	Purpose
Step 1	switch# configure terminal	Enters global configuration mode.
Step 2	[no] feature sflow	Enables the sFlow feature.
Step 3	show feature	(Optional) Displays enabled and disabled features.
Step 4	switch(config)# copy running-config startup-config	(Optional) Saves the change persistently through reboots and restarts by copying the running configuration to the startup configuration.

The following example shows how to enable the sFlow feature:

```
switch# configure terminal
switch(config)# feature sflow
switch(config)# copy running-config startup-config
```

Configuring the Sampling Rate

Before You Begin

Ensure that you have enabled the sFlow feature.

Procedure

	Command or Action	Purpose
Step 1	switch# configure terminal	Enters global configuration mode.
Step 2	[no] sflow sampling-rate <i>sampling-rate</i>	Configures the sFlow sampling rate for packets. The <i>sampling-rate</i> can be an integer between 4096-1000000000. The default value is 4096.
Step 3	show sflow	(Optional) Displays sFlow information.

	Command or Action	Purpose
Step 4	switch(config)# copy running-config startup-config	(Optional) Saves the change persistently through reboots and restarts by copying the running configuration to the startup configuration.

This example shows how to set the sampling rate to 50,000:

```
switch# configure terminal
switch(config)# sflow sampling-rate 50000
switch(config)# copy running-config startup-config
```

Configuring the Maximum Sampled Size

You can configure the maximum number of bytes that should be copied from a sampled packet.

Before You Begin

Ensure that you have enabled the sFlow feature.

Procedure

	Command or Action	Purpose
Step 1	switch# configure terminal	Enters global configuration mode.
Step 2	[no] sflow max-sampled-size sampling-size	Configures the sFlow maximum sampling size packets. The range for the <i>sampling-size</i> is from 64 to 256 bytes. The default value is 128.
Step 3	show sflow	(Optional) Displays sFlow information.
Step 4	switch(config)# copy running-config startup-config	(Optional) Saves the change persistently through reboots and restarts by copying the running configuration to the startup configuration.

This example shows how to configure the maximum sampling size for the sFlow Agent:

```
switch# configure terminal
switch(config)# sflow max-sampled-size 200
switch(config)# copy running-config startup-config
```

Configuring the Counter Poll Interval

You can configure the maximum number of seconds between successive samples of the counters that are associated with the data source. A sampling interval of 0 disables counter sampling.

Before You Begin

Ensure that you have enabled the sFlow feature.

Procedure

	Command or Action	Purpose
Step 1	switch# configure terminal	Enters global configuration mode.
Step 2	[no] sflow counter-poll-interval <i>poll-interval</i>	Configures the sFlow poll interval for an interface. The range for the <i>poll-interval</i> is from 0 to 2147483647 seconds. The default value is 20.
Step 3	show sflow	(Optional) Displays sFlow information.
Step 4	switch(config)# copy running-config startup-config	(Optional) Saves the change persistently through reboots and restarts by copying the running configuration to the startup configuration.

This example shows how to configure the sFlow poll interval for an interface:

```
switch# configure terminal
switch(config)# sflow counter-poll-interval 100
switch(config)# copy running-config startup-config
```

Configuring the Maximum Datagram Size

You can configure the maximum number of data bytes that can be sent in a single sample datagram.

Before You Begin

Ensure that you have enabled the sFlow feature.

Procedure

	Command or Action	Purpose
Step 1	switch# configure terminal	Enters global configuration mode.
Step 2	[no] sflow max-datagram-size <i>datagram-size</i>	Configures the sFlow maximum datagram size. The range for the <i>datagram-size</i> is from 200 to 9000 bytes. The default value is 1400.
Step 3	show sflow	(Optional) Displays sFlow information.

	Command or Action	Purpose
Step 4	switch(config)# copy running-config startup-config	(Optional) Saves the change persistently through reboots and restarts by copying the running configuration to the startup configuration.

This example shows how to configure the sFlow maximum datagram size:

```
switch# configure terminal
switch(config)# sflow max-datagram-size 2000
switch(config)# copy running-config startup-config
[#####] 100%
```

Configuring the sFlow Analyzer Address

Before You Begin

Ensure that you have enabled the sFlow feature.

Procedure

	Command or Action	Purpose
Step 1	switch# configure terminal	Enters global configuration mode.
Step 2	[no] sflow collector-ip <i>IP-address vrf-instance</i>	Configures the IPv4 address for the sFlow Analyzer. <i>vrf-instance</i> can be one of the following: <ul style="list-style-type: none"> • A user-defined VRF name—You can specify a maximum of 32 alphanumeric characters. • vrf management— You must use this option if the sFlow data collector is on the network connected to the management port. • vrf default— You must use this option if the sFlow data collector is on the network connected to the front panel ports.
Step 3	show sflow	(Optional) Displays sFlow information.
Step 4	switch(config)# copy running-config startup-config	(Optional) Saves the change persistently through reboots and restarts by copying the running configuration to the startup configuration.

This example shows how to configure the IPv4 address of the sFlow data collector that is connected to the management port:

```
switch# configure terminal
switch(config)# sflow collector-ip 192.0.2.5 vrf management
switch(config)# copy running-config startup-config
```

Configuring the sFlow Analyzer Port

You can configure the destination port for sFlow datagrams.

Before You Begin

Ensure that you have enabled the sFlow feature.

Procedure

	Command or Action	Purpose
Step 1	switch# configure terminal	Enters global configuration mode.
Step 2	[no] sflow collector-port <i>collector-port</i>	Configures the UDP port of the sFlow Analyzer. The range for the <i>collector-port</i> is from 0 to 65535. The default value is 6343.
Step 3	show sflow	(Optional) Displays sFlow information.
Step 4	switch(config)# copy running-config startup-config	(Optional) Saves the change persistently through reboots and restarts by copying the running configuration to the startup configuration.

This example shows how to configure the destination port for sFlow datagrams:

```
switch# configure terminal
switch(config)# sflow collector-port 7000
switch(config)# copy running-config startup-config
[#####] 100%
switch(config)#
```

Configuring the sFlow Agent Address

Before You Begin

Ensure that you have enabled the sFlow feature.

Procedure

	Command or Action	Purpose
Step 1	switch# configure terminal	Enters global configuration mode.
Step 2	[no] sflow agent-ip <i>ip-address</i>	Configures the IPv4 address of the sFlow Agent. The default <i>ip-address</i> is 0.0.0.0, which means that all sampling is disabled on the switch. You must specify a valid IP address to enable sFlow functionality.
Step 3	show sflow	(Optional) Displays sFlow information.
Step 4	switch(config)# copy running-config startup-config	(Optional) Saves the change persistently through reboots and restarts by copying the running configuration to the startup configuration.

This example shows how to configure the IPv4 address of the sFlow Agent:

```
switch# configure terminal
switch(config)# sflow agent-ip 192.0.2.3
switch(config)# copy running-config startup-config
```

Configuring the sFlow Sampling Data Source

The sFlow sampling data source can be an Ethernet port, a range of Ethernet ports, or a port channel.

Before You Begin

- Ensure that you have enabled the sFlow feature.
- If you want to use a port channel as the data source, ensure that you have already configured the port channel and you know the port channel number.

Procedure

	Command or Action	Purpose
Step 1	switch# configure terminal	Enters global configuration mode.
Step 2	switch(config)# [no] sflow data-source interface [ethernet <i>slot/port</i> [- <i>port</i>] port-channel <i>channel-number</i>]	Configures the sFlow sampling data source. For an Ethernet data source, <i>slot</i> is the slot number and <i>port</i> can be either a single port number or a range of ports designated as <i>port-port</i> .
Step 3	switch(config)# show sflow	(Optional) Displays sFlow information.

	Command or Action	Purpose
Step 4	switch(config)# copy running-config startup-config	(Optional) Saves the change persistently through reboots and restarts by copying the running configuration to the startup configuration.

This example shows how to configure Ethernet ports 5 through 12 for the sFlow sampler:

```
switch# configure terminal
switch(config)# sflow data-source interface ethernet 1/5-12
switch(config)# copy running-config startup-config
[#####] 100%
switch(config)#
```

This example shows how to configure port channel 100 for the sFlow sampler:

```
switch# configure terminal
switch(config)# sflow data-source interface port-channel 100
switch(config)# copy running-config startup-config
[#####] 100%
switch(config)#
```

Verifying the sFlow Configuration

Use the following commands to verify the sFlow configuration information:

Command	Purpose
show sflow	Displays the sFlow global configuration.
show sflow statistics	Displays the sFlow statistics.
clear sflow statistics	Clears the sFlow statistics.
show running-config sflow [all]	Displays the current running sFlow configuration.

Configuration Examples for sFlow

This example shows how to configure sFlow:

```
feature sflow
sflow sampling-rate 5000 sflow
max-sampled-size 200 sflow
counter-poll-interval 100 sflow
max-datagram-size 2000
sflow collector-ip 192.0.2.5 vrf
management sflow collector-port 7000
sflow agent-ip 192.0.2.3
sflow data-source interface ethernet 1/5
```

Additional References for sFlow

Table 33: Related Documents for sFlow

Related Topic	Document Title
RFC 3176	Defines the sFlow packet format and SNMP MIB. http://www.sflow.org/rfc3176.txt

